



**BANEDANMARK**

# **ORF**

## **Operational Rules for fjernbane**

**ORF-26-1 valid from 02.02.2026**

## Changes since previous version

---

**Roles**

"Catenary field leader"

It is made clear in the description of the role, that the Catenary field leader manages and supervises all work related to the catenary system.

**Definitions**

Editorial changes have been made to the following definitions: "Start of ATC-signalling", "Start of ETCS-signalling", "End of ETCS-signalling", "Operational Instructions", "Axle counter", "End of authority" and "Authority to move".

"Point position indicators"

Illustrations of Point position indicators displays have been added.

"Observations during driving"

The procedure "Normal operation - Observations while driving" is changed, so that all matters relating to the Driver always being aware of the condition of the infrastructure, passing trains and vehicles and other matters that may affect operations are moved to a new definition "Observations during driving".

**Procedures**

Editorial changes have been made to the following procedures: "Handling of UT", "Driving into an occupied track section", "Signaller handover", "Passing a level crossing without a movement authority", "Implementing an unplanned speed restriction", "Impact with object and/or derailment" and "Electrical rolling stock in earthed area".

"Handling of area with data radio hole"

A new procedure has been added that describes the handling of a data radio hole, both planned and unplanned. At the same time, the procedure determines the safety requirements that apply to the Signaller when a data radio hole has been activated in the signalling system.

.

"Vigilance while driving"

The procedure has been moved from "Normal operation" to "Incidents". This means that the procedure now only applies in situations where the Signaller has received a report of irregularities that may affect railway safety or operations.

Read the definition "Observations during driving".

"Reset of axle counter section in a possession"

A new procedure has been added describing how to reset an axle counter section in a possession. The procedure has been temporarily in force in a supplementary safety provision.

"Establish possession without handheld terminal" and "End possession without handheld terminal"

A new requirement has been added that the establishment of a possession without a handheld terminal and the ending of a possession without a handheld terminal must be agreed with the Person responsible for traffic operation.

In the section Rules for Working and walking about in the Infrastructure, it has been added that the Person responsible for traffic operation must ensure that the agreements regarding the establishment of a track closure without a handheld terminal and the ending of a possession without a handheld terminal must be announced to the Signaller and the PICOP to the relevant extent.

### **Rules for Working and walking about in the Infrastructure**

Extensive editorial changes have been made to the entire section. A new section has been added regarding the PICOSS's responsibilities before work is started. At the same time, the conditions that must be met before the PICOP can declare "that the area is safe for operations " have been added.

## **Reader's instructions**

---

IN.2		Throughout the document the reader will notice that symbols have been used to identify certain statements.
IN.3	Ⓜ	Procedure symbol. The symbol indicates that a Railway Undertaking procedure exists to support ORF e.g. procedures ensuring safe parking of rolling stock is a procedure put in place by the Railway Undertaking (RU).
IN.5	Ⓢ	System restrictions. The symbol is used to provide information concerning system functionality, e.g. if a Driver fails to control the train to a standstill at an End of Authority, the onboard system will command a brake intervention.

## Area of validity

---

IN.45            ORF apply to driving of trains, shunting and operation and maintenance, on the parts of the Fjernbane infrastructure equipped with ETCS and on shunting areas adjacent to these areas.

Exceptions to ORF will be described by location specific description or "supplerende sikkerhedsbestemmelser" applicable to these areas.

## Fundamental principles

---

- IN.40 The core aim of the fundamental operational principles is to enable the safe and timely delivery of people and goods to their destination.
- IN.41 Fundamental operational principles:
- IN.42
1. The method of signalling must maintain a spatial separation between trains that is safe.
  2. Before a train is allowed to start or continue moving, it must have an authority to move that clearly indicates the limits of that authority.
  3. Trains proceeding over any portion of line must not be obstructed in a way that threatens their safety.
  4. Trains must be prevented from proceeding onto a portion of line if it is known or suspected that it would not be safe for them to pass.
  5. Trains must not be allowed to begin or continue their missions until it is clear that it is safe for them to do so.
  6. Trains must only be allowed to operate over any portion of line as long as the rolling stock is compatible with the infrastructure on that portion of line.
  7. Trains must not continue to operate after they have been found to be unsafe in any respect, until measures have been taken to allow them to continue safely.
  8. People must be kept a safe distance from moving trains.
  9. The workforce must be protected from the hazards associated with the operational railway.
- IN.43 The fundamental principles are to provide guidance to staff while performing their duties on or about the operational railway infrastructure. These principles have been identified as a method to help guide behaviour to ensure safe and efficient rail traffic operations.

# Roles

---

- RF.110 A user role is not an individual but a defined area of responsibility that is referenced under the heading of the user role. One individual may be competent and licensed to perform the duties of more than one role, for example a user may act as both PICOP and Shunter. Additionally, a user role may be delegated and divided between more than one individual, e.g. the role of Network manager represents both the Infrastructure Manager and all of the applicable Railway Undertakings. Role descriptions and job descriptions are not to be confused. A role description is applied to one or more competent individuals but a job description is specified for each person, and is not part of ORF.
- RF.112 All individuals employed to undertake activities on the railway infrastructure controlled by Banedanmark must undertake these activities within the constraints of a defined role. Individuals are permitted to undertake activities for several roles provided they are competent for each role, and there is no conflict or reduction in safety when performing activities.
- RF.113 The applicable role is indicated next to all rules and some definitions. Roles and responsibilities are defined here and are used to empower the users to use their training and competence within the limits set out as the authority of the role.
- RF.114 All roles engaging in activity on infrastructure controlled by Banedanmark have a shared responsibility to alert the Signaller, Emergency services or their immediate supervisor if they become aware of a potentially hazardous situation.
- RF.115 Railway Undertaking roles are defined by the Railway Undertaking, and may resemble a role defined by Banedanmark in OR. These roles and their connected responsibilities are only used internally in the Railway Undertaking procedures, and they do not substitute any of the roles and responsibilities regulated by OR.

## RF.1 **Signaller**

- RF.2 DEFINITION The Signaller works within the traffic control centre and is responsible for the day-to-day management of all operations within the area controlled by the Signaller. The Signaller cooperates with all relevant parties to perform these duties.

The Signaller controls the operation of trains and maintenance operation in a designated control area by the use of the traffic management systems.

## RF.9 **Driver**

- RF.10 DEFINITION The Driver is responsible for the safe movement of a train or a vehicle. This includes observing the maximum permitted speed and controlling the brakes.

The Driver must have the necessary knowledge about the infrastructure and the location specific descriptions which apply to the area where the train will drive.

## RF.38 **O&M coordinator**

- RF.39 DEFINITION The O&M coordinator (Operations and Maintenance) is responsible for supervising the status of the infrastructure. The O&M coordinator is responsible for overall coordination of maintenance and fault correction and for ensuring that the relevant staff is called in for various tasks such as undetected points, axle counter faults, broken rails or balise errors.

RF.14		<b>Shunter</b>
RF.15	<u>DEFINITION</u>	The Shunter is responsible for the safe movement of rolling stock within a designated shunting area, on a route for shunting or in a possession.
		The Shunter can only be responsible for the movement in areas where the Shunter has the necessary knowledge about the infrastructure and the location specific descriptions which apply to the area.
		The responsibilities of a Shunter can be performed by a Driver provided that the traction and brakes can be controlled from the front end cab for the direction of travel.
RF.19		<b>Shunting area manager</b>
RF.20	<u>DEFINITION</u>	The Shunting area manager is responsible for the safe coordination of movements of rolling stock within a designated shunting area and has the necessary knowledge about the infrastructure and the location specific descriptions which apply to the area.
		The Shunting area manager coordinates all entries and exits from the shunting area with the Signaller.
		The responsibilities of a Shunting area manager can be performed by a Shunter.
RF.34		<b>Bridge guard</b>
RF.35	<u>DEFINITION</u>	The Bridge guard is responsible for ensuring that the bridge infrastructure is safe for the passage of trains when required, and the bridge infrastructure is moved to accommodate the movement of other forms of traffic when required.
RF.26		<b>PICOSS</b>
RF.27	<u>DEFINITION</u>	The Person in charge of site safety (PICOSS) is responsible for safety at any worksite where work takes place in the tracks or in close proximity to the tracks. A PICOSS is required both for planned work and for corrective maintenance.
RF.45		<b>Assistant PICOSS</b>
RF.46	<u>DEFINITION</u>	The Assistant PICOSS assists the PICOSS and can only have the responsibility for part of the work under the control of the PICOSS.
RF.22		<b>PICOP</b>
RF.23	<u>DEFINITION</u>	The Person in charge of possession (PICOP) is responsible for railway safety including all movements taking place inside a possession agreed with the Signaller and all safety related communication regarding this. The communication between the PICOP and the Signaller is expected, but not limited, to take place by the use of a handheld terminal.
		The PICOP performs the responsibilities of a Shunting area manager in a possession.



RF.48		<b>Work supervisor</b>
RF.49	<u>DEFINITION</u>	The Work supervisor is responsible for controlling and communicating with the PICOSS all issues regarding the technical installations where they are expected to have either a safety or a punctuality impact on the operation of the railway.
RF.42		<b>Maintainer</b>
RF.43	<u>DEFINITION</u>	The Maintainer has specific technical skills and works in the infrastructure and/or surrounding railway buildings either with or without possession. The Maintainer may be accompanied by working units and other track vehicles.
RF.51		<b>Watchman</b>
RF.52	<u>DEFINITION</u>	The Watchman is responsible for warning personnel working within the personal safety distance where no possession has been established.
RF.60		<b>Contractor</b>
RF.61	<u>DEFINITION</u>	The Contractor is a company that contracts to undertake work within the infrastructure managed by Banedanmark. The contractor is responsible for ensuring that any work that is planned to take place has employed the necessary safety measures.
RF.63		<b>TWSC</b>
RF.64	<u>DEFINITION</u>	In the case of infrastructure works, the Track Work Safety Coordinator (TWSC) is responsible for assessing railway safety, to approve railway safety plans, to supervise the execution of infrastructure works and ensuring compensatory measures, if the safety level is lowered.
RF.30		<b>Catenary manager</b>
RF.31	<u>DEFINITION</u>	The Catenary manager is a competent person who is appointed in writing to control the switching and operating condition of the high-voltage system, including conducting couplings in connection with work on or near high-voltage systems.
RF.66		<b>Catenary field leader</b>
RF.67	<u>DEFINITION</u>	The Catenary field leader is a competent person who, on behalf of the Catenary manager, performs earthing and issues work permit. The Catenary field leader manages and supervises everything related to work in and at the catenary system.

RF.119

## **Dispatcher**

RF.120

### DEFINITION

The Dispatcher works within the traffic control centre and is responsible for disposing railway traffic within the allocated area. The Dispatcher decides in accordance with current service agreements in the event of deviations from the production plan, and in the event of major irregularities coordinate with Signaller, the O&M coordinator, the Network manager and relevant Railway undertakings.

The Dispatcher is responsible for ensuring that the production plan in the signaling system is up to date at all times.

RF.69

## **Network manager**

RF.70

### DEFINITION

The Network manager is responsible for coordinating the railway traffic during disruptions, in cooperation with the Dispatcher, Signaller, Railway Undertakings, Emergency services, Contractors and other relevant parties using or working on the rail network managed by Banedanmark.

RF.73

## **Person responsible for traffic operation**

RF.74

### DEFINITION

The Person responsible for traffic operation is responsible for ensuring traffic operation takes place according to rules and regulations and that necessary competence and resource is available to perform the traffic operation tasks. The Person responsible for traffic operation agrees and coordinates temporary rules and railway safety issues.

If parts of the responsibility are delegated a written agreement must be produced describing the detailed and specific placement of the responsibility.

RF.117

## **Person responsible for operational rules**

RF.118

The Person responsible for operational rules has the responsibility of ORF and additional instructions in connection with these. The Person responsible for operational rules has the right to interpret ORF as well as the additional provisions in connection with these.

The Person responsible for operational rules ensures that new or updated rules and derogations for existing rules are processed and approved.

RF.77

## **Person responsible for technical operation**

RF.78

### DEFINITION

The Person responsible for technical operation is a technical specialist responsible for the operational condition of the technical installations of the Banedanmark rail network.

RF.81

## Banedanmark incident investigator

RF.82

### DEFINITION

During accidents or safety related incidents, the Banedanmark incident investigator is responsible for carrying out the immediate incident investigation.

During accidents, the Banedanmark incident investigator has authority to implement and manage the necessary measures to assist the Emergency services in ensuring that the tracks are cleared and the service is restored.

The Banedanmark incident investigator makes the necessary coordination of the investigations with both external authorities, internal units and railway undertakings.

The Banedanmark incident investigator is responsible for cooperation with the Danish Accident Investigation Board.

The Banedanmark incident investigator is authorised to revoke any permission to perform safety related tasks from any staff if:

- severe violations of safety regulations have been observed
- considerable safety considerations have been ignored
- questionable staff competence has been observed.

## Definitions

---

OR.DEF.683

### DMI symbols and marker boards

OR.DEF.211

### Indicated running level

OR.DEF.212

#### DEFINITION

The active running level is indicated on the DMI by a level indication. The level indicates how the train is supervised and the operational rules that must be applied by the Driver.

The route book contains information identifying the level of the train control system for the infrastructure.

The indicated running level may, during shunting with working units in a possession in the transition area, deviate from the correct level according to the Route when the onboard is in SH-mode.

#### Responsibilities

OR.DEF.213

Driver

When the symbol for running in level 0 is displayed you must observe operational rules for the level 0 area.



During shunting movements past the system border to the level 2 area in SH-mode, you must observe ORF.

OR.DEF.214

Driver

When the symbol for running in level ATC (Automatic Train Control) is displayed you must observe operational rules for the level ATC area.



OR.DEF.215

Driver

When the symbol for running in level 2 is displayed you must observe ORF.



During shunting movements past the system border to the level 0/ATC area in SH-mode, between possessions in the transition area, you must regardless of the indicated running level in the DMI observe the applicable operational rules for the level 0/ATC area.

OR.DEF.216

Driver

You must bring the train to a standstill and inform the Signaller when the level indicated on the DMI is not consistent with the infrastructure you are occupying.

OR.DEF.104

## Announced data radio hole

OR.DEF.105

### DEFINITION

An announced data radio hole is an area known to have unreliable data radio coverage. When a train encounters an announced data radio hole the onboard will automatically suspend the monitoring of the data radio connection until the train has exited the announced data radio hole.

### Responsibilities

OR.DEF.106

### Driver

When the symbol for an announced data radio hole is displayed on the DMI you may continue on any valid movement authority displayed on the DMI. If you reach the end of authority and the symbol for data radio hole is still displayed the movement authority cannot be updated and you must contact the Signaller.



OR.DEF.294

## Dual faced stop marker

OR.DEF.295

### DEFINITION

A dual faced stop marker is a moveable sign placed in between the rails which shows "STOP" on both sides. "STOP" is indicated as a white circle with a red disc inside.

The dual faced stop marker indicates the boundaries of a worksite within a possession. The purpose of the dual faced stop marker is to act as the last barrier against unauthorised movement into or out of a worksite. All movements must stop at the marker until authorised by the PICOP to pass.

### Responsibilities

OR.DEF.296

### Driver

You must bring your train or vehicle to a standstill before reaching the stop marker.

You may only proceed when the PICOP has authorised the movement and the stop marker has been removed from the track.

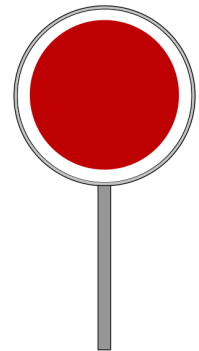

OR.DEF.431

**ETCS stop marker**

OR.DEF.432

DEFINITION

An ETCS stop marker indicates the end location for authorities to move and are also used to demarcate shunting areas, possessions, and level crossings.

An ETCS stop marker shows a yellow arrow pointing at the track for which it applies and is associated with a marker containing a unique identifier.

The location of ETCS stop markers is indicated in the Route Book and on the signalling control display.

When an ETCS stop marker is placed in front of a level crossing it will be equipped with an additional marker indicating the ID number of the level crossing.

ETCS stop markers are only passed on movement authorities, an Operational Instruction authority or when authorised by a Shunter.

ETCS stop markers may be passive. This means that they cannot be used for route setting or as a delimitation of a possession or a temporary shunting area. Passive ETCS stop markers are not equipped with RFID-tag (Radio-frequency identification). Passive ETCS stop markers are marked in the infrastructure with white reflective tape with the text "Ingen RFID" and have a special marking in the Route Book and on the signalling control display.

Responsibilities

OR.DEF.433

**Driver**

You must only allow your train or vehicle to pass an ETCS stop marker when authorised by a movement authority, an Operational Instruction or by the responsible Shunter.

If you identify that the ETCS stop marker at the limit of your authority when running on an Operational Instruction authorisation is missing, you must bring your train to a standstill and request further instructions from the Signaller.

If you identify that an ETCS stop marker is missing or obscured, you must always inform the Signaller.



OR.DEF.242

**Data radio communication failure**

OR.DEF.243

DEFINITION

A data radio communication failure exists when the onboard is unable to establish radio communication to the RBC.

Responsibilities

OR.DEF.244

**Driver**

When the symbol for data radio communication failure is displayed on the DMI you must verify and correct the information on the DMI used to create the connection. You must check that the ETCS level, radio network identification and RBC phone number are correct as provided by the Route Book.



OR.DEF.141

## Exit SH-mode

OR.DEF.142

### DEFINITION

Exit SH-mode is done by the Driver using the "Exit Shunting" button on the DMI when all shunting movements to be performed in the area by that train has ended. When leaving SH-mode the onboard changes to SB-mode.

### Responsibilities

OR.DEF.143

Driver

You must press the "Exit Shunting" button on the DMI when instructed by the Shunter.

OR.DEF.598

## Fouling point

OR.DEF.599

### DEFINITION

The fouling point indicator is placed where two tracks intersect or converge onto each other and indicates the minimum distance necessary to the neighbouring track in order for any rolling stock to stay outside the safe gauge of the neighbouring track.

### Responsibilities

OR.DEF.600

Driver

When you are parking rolling, you must ensure that no part of the rolling stock is located between the fouling point indicator and the point to which it belongs.

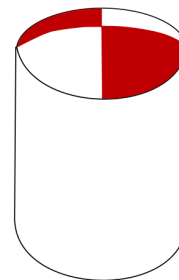

OR.DEF.18

## FS-mode

OR.DEF.19

### DEFINITION

FS-mode (Full Supervision mode) is a fully supervised driving mode offered to the onboard by the signalling system. FS-mode cannot be selected by the Driver.

FS-mode allows movements on a FS MA with the signalling system ensuring that the technical conditions for issuing a movement authority are met.

The train is supervised to the most restrictive speed profile. This takes into account the allowed speed of train consist, line speed, speed restrictions, level crossing restrictions and an end of authority.

The supervision is based on the speed and location of the train to ensure that the train remains within the speed and distance limits.

### Responsibilities

OR.DEF.20

#### Driver

You must control the train within the permitted speed indicated on the DMI as long as the symbol for FS-mode is shown on the DMI.

As long as the text message "Entering FS" is displayed on your DMI you must observe any speed restriction related to the part of your train not yet covered by the FS MA. The speed must not exceed 25 km/h when the message is indicated while driving from a possession or shunting area and 40 km/h when the message is indicated while driving in an interlocked area.





OR.DEF.28

**Low adhesion setting**

OR.DEF.29

**DEFINITION**

Rolling stock specific alteration of the train's calculated stopping distance to be more restrictive.

The low adhesion setting is only an assisting tool for the Driver and does not provide any guarantee that the train will not overrun the end of authority during braking.

The low adhesion setting can be ordered by the signalling system when the train enters an active low adhesion area, or manually activated by the Driver.

When the low adhesion setting is ordered by the signalling system, the low adhesion setting is removed when the train exits the active low adhesion area, or the area is de-activated in the signalling system.

When the Driver manually activates the low adhesion setting, it will remain active until the Driver manually cancels the setting.

**Responsibilities**

OR.DEF.30

**Driver**

When the symbol for low adhesion setting is shown the low adhesion setting is activated. You must control the train according to the low adhesion conditions experienced and not rely on the onboard to protect against overrun of the end of authority during braking.



OR.DEF.69

**Keep main circuit breaker open**

OR.DEF.70

**DEFINITION**

Keep main circuit breaker open marks the section where the main circuit breaker must remain open.

**Responsibilities**

OR.DEF.71

**Driver**

When the symbol for keep main circuit breaker open is displayed on the DMI you must keep the main circuit breaker open until the symbol to close main circuit breaker is shown.



OR.DEF.40

**Keep pantograph lowered**

OR.DEF.41

**DEFINITION**

Keep pantograph lowered marks the area where the pantograph(s) must remain lowered.

**Responsibilities**

OR.DEF.42

**Driver**

When the symbol for keep pantograph lowered is displayed on the DMI you must keep the pantograph(s) lowered until the symbol to raise the pantograph is shown.



OR.DEF.72

## Close main circuit breaker

OR.DEF.73

### DEFINITION

Close main circuit breaker marks the end of a neutral section and will be indicated on the DMI when the front of the train has passed the neutral section.

### Responsibilities

OR.DEF.74

Driver

You may close the main circuit breaker when the electrical rolling stock has passed the close main circuit breaker marker.

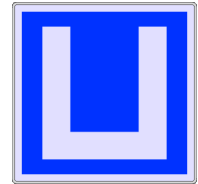
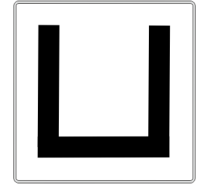

OR.DEF.75

Driver

When the symbol for close main circuit breaker is displayed on the DMI it indicates that the front of the train has passed the neutral section. You may close the main circuit breaker when the electrical rolling stock has passed the neutral section.



The DMI will indicate the symbol in grey if closing the main circuit breaker happens automatically.

OR.DEF.65

## Open main circuit breaker

OR.DEF.66

### DEFINITION

Open main circuit breaker is an indication on the DMI that the train is approaching a neutral section and the Driver must be prepared to open the main circuit breaker.

### Responsibilities

OR.DEF.67

Driver

When the symbol for open main circuit breaker is displayed on the DMI you must be prepared to open the main circuit breaker before the train reaches the neutral section.



The DMI will indicate the symbol in grey if opening of the main circuit breaker happens automatically.

OR.DEF.68

Driver

You must open the main circuit breaker before the train reaches the open main circuit breaker marker.

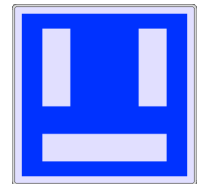
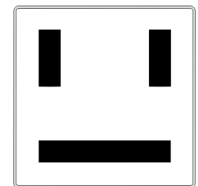

OR.DEF.662

Driver

You must immediately inform the Signaller in case your train enters a neutral section with the main circuit breaker closed.

OR.DEF.43

## Raise pantograph

OR.DEF.44

### DEFINITION

Raise pantograph marks the end of a lowered pantograph area. The pantograph(s) on an electric traction unit can be raised once the electrical rolling stock has passed out of the lowered pantograph area.

### Responsibilities

OR.DEF.45

Driver

You may begin raising the pantograph(s) when the electrical rolling stock has passed the raise pantograph marker.

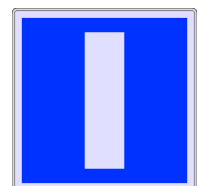
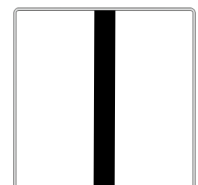

OR.DEF.46

Driver

When the symbol for raise pantograph is displayed on the DMI it indicates that the front of the train has passed the lowered pantograph area. You may raise the pantograph(s) when the electrical rolling stock has left the lower pantograph area.



OR.DEF.455

**Unprotected level crossing**

OR.DEF.456

**DEFINITION**

A level crossing is unprotected until the signalling system reports that it is protected.

All supervised trains with a movement authority across an unprotected level crossing will have the unprotected level crossing symbol displayed in the DMI along with and a speed restriction of 10 km/h covering the width of the level crossing. The symbol and speed restriction will normally be lifted, when the level crossing is reported as protected by the signaling system, or when the lead cab has passed the unprotected level crossing.

In exceptional cases where more level crossings are placed close after each other, it can happen that the symbol is still indicated after the level crossing is reported as protected by the signaling system and the speed restriction is lifted. In this case the symbol applies to the next level crossing which is not yet protected.

A train travelling over an unprotected level crossing will be released from the level crossing speed restriction of 10 km/h, when the lead cab has passed the level crossing.

If a train is approaching an end of authority where a level crossing is located immediately after, the symbol may also be displayed. The symbol is only applicable for trains passing the level crossing.

**Responsibilities**

OR.DEF.457

**Driver**

When the symbol for an unprotected level crossing is displayed on your DMI along with a speed restriction of 10 km/h, or when the information is included on an Operational Instruction, you must consider the level crossing to be unprotected.



OR.DEF.595

**Kilometre marker**

OR.DEF.596

**DEFINITION**

A kilometre marker is a trackside sign indicating the distance from a fixed starting point.

The top number indicates the kilometres travelled and the bottom number indicates the first digit after the decimal point of the distance measure per. 100 metres.

The kilometre markers are placed at 200 metre intervals.

**Responsibilities**

OR.DEF.597

**Driver**

You must observe kilometre markers to assist your knowledge of your position in the infrastructure.



OR.DEF.206

**Acknowledge Level Transition**

OR.DEF.207

DEFINITION

Level transitions must be acknowledged where the Driver is required to perform safety related operations that would have been performed by the previous signalling system.

If the Driver does not acknowledge the change in supervision, the onboard will perform a brake intervention.

Responsibilities

OR.DEF.208

Driver

When the symbol requesting an acknowledgment of entry into level 0 is displayed on the DMI you may acknowledge and then apply the operational rules for the Level 0 area.



OR.DEF.209

Driver

When the symbol requesting an acknowledgment of entry into level ATC is displayed on the DMI you may acknowledge and then apply the operational rules for the Level ATC area.



OR.DEF.210

Driver

When the symbol requesting an acknowledgment of entry into level 2 is displayed on the DMI you may acknowledge and then apply ORF.



OR.DEF.78

**Acknowledge OS-mode**

OR.DEF.79

DEFINITION

Acknowledge OS-mode indicates that the signalling system requires the onboard to change driving mode into OS-mode.

If the Driver fails to acknowledge OS-mode, the train is supervised to a standstill at the ETCS stop marker indicating the end of authority.

Responsibilities

OR.DEF.80

Driver

When the symbol for acknowledge OS-mode is indicated on the DMI you may acknowledge. By acknowledging OS-mode you are accepting a change into OS-mode and you must observe the conditions for running on sight.



OR.DEF.133

**Acknowledge SH-mode**

OR.DEF.134

**DEFINITION**

Acknowledge SH-mode can be offered by the signalling system for the Driver to acknowledge.

If the Driver fails to acknowledge SH-mode, the onboard switches automatically to SH-mode and triggers a timer of 5 seconds for the Driver to acknowledge. If the Driver does not acknowledge within the 5 seconds, the onboard will automatically perform a brake intervention.

**Responsibilities**

OR.DEF.135

**Driver**

When the symbol on the DMI indicates an order from the signalling system to change to SH-mode, you must only acknowledge the change if agreed with the Shunter. If you are offered to acknowledge SH-mode in a situation where shunting is not expected, you must inform the Signaller.



You must not accept a change to SH-mode if you are driving a passenger train.

OR.DEF.137

**Driver**

You must only request or acknowledge the change to SH-mode if you definitely know that the train is prepared for the specific shunting movement.

OR.DEF.152

**Acknowledge SN-mode**

OR.DEF.153

**DEFINITION**

Acknowledge SN-mode indicates that the signalling system requires the onboard to change driving mode into SN-mode.

If the Driver fails to acknowledge SN-mode, the onboard will automatically perform a brake intervention. Upon acknowledgement of SN-mode the brake intervention will be released.

**Responsibilities**

OR.DEF.154

**Driver**

When the symbol for acknowledge SN-mode is indicated on the DMI you may acknowledge the change in supervision if you are at a location compatible with SN-mode. By acknowledging SN-mode you are confirming that you understand the change in applicable operational rules and that you are accepting a change into SN-mode.



OR.DEF.703

## Acknowledge SR-mode

OR.DEF.704

### DEFINITION

Acknowledge SR-mode indicates that the signalling system requires the onboard to change driving mode into SR-mode.

### Responsibilities

OR.DEF.705

Driver

When the symbol for acknowledge SR-mode is indicated on the DMI, you must only acknowledge SR-mode when the relevant Operational Instruction is issued by the Signaller.



By acknowledging SR-mode you are confirming that you understand the change in supervision, and that you are accepting a change into SR-mode.

OR.DEF.192

## Acknowledge TR-mode

OR.DEF.193

### DEFINITION

Acknowledge TR-mode is a confirmation from the Driver that the emergency brake application has been noted. Following an acknowledgement of TR-mode the onboard will enter into PT-mode.

### Responsibilities

OR.DEF.194

Driver

When the symbol for acknowledge TR-mode is displayed on the DMI you may acknowledge the change to PT-mode.



OR.DEF.230

## Acknowledge UN-mode

OR.DEF.231

### DEFINITION

UN-mode must be acknowledged before the onboard can change driving mode into UN-mode.

### Responsibilities

OR.DEF.232

Driver

When the symbol for acknowledge UN-mode is indicated on the DMI you may acknowledge. You may only acknowledge UN-mode if a change into UN-mode is appropriate for the area and you are competent in the operational rules of the area.



By acknowledging UN-mode you accept a change into UN-mode, and you must observe the operational rules specific to the level 0 or level ATC area.

OR.DEF.200

**Announce Level Transition**

OR.DEF.201

DEFINITION

The Driver will be warned when approaching a level transition about which level of control the train will be entering.

The announcement will be displayed as an indication on the DMI.

Responsibilities

OR.DEF.202

Driver

The symbol announcing a transition to level 0 is displayed on the DMI when approaching a location of transition into level 0.



OR.DEF.203

Driver

The symbol announcing a transition to level ATC is displayed on the DMI when approaching a location of transition into level ATC.



OR.DEF.204

Driver

The symbol announcing a transition to level 2 is displayed on the DMI when approaching a location of transition into level 2.



OR.DEF.205

Driver

You must not allow your train to enter an area where you are not competent to run under the announced level.

If you do not expect to make a transition to the level indicated, you must stop the train no later than the system border and inform the Signaller.

OR.DEF.679

**Attention marker**

OR.DEF.680

DEFINITION

An Attention marker specifies the location where the Driver will sound the train horn to warn members of the public that a train is approaching.

The Attention marker is placed at non interlocked level crossings with low or limited sighting distances.

Responsibilities

OR.DEF.681

Driver

You must sound the train horn with sound signal "Warning" when passing the Attention marker.



OR.DEF.682

Driver

You must sound the train horn with sound signal "Warning" when passing the Attention marker in case of low visibility.



OR.DEF.54

**NL-mode**

OR.DEF.55

DEFINITION

Not used in Denmark



OR.DEF.906

## Staying on the side of trains and vehicles prohibited

OR.DEF.907

### DEFINITION

The marker "Staying on the side of trains and vehicles prohibited" marks places where it is not permitted to stay on the side of trains or vehicles.

The marker is placed at trackside where objects are within the safety distance for shunting staff.

### Responsibilities

OR.DEF.909

### Shunter

Before passing the marker, you must ensure that there are no staff on the side of trains or vehicles.



OR.DEF.81

## OS-mode

OR.DEF.82

### DEFINITION

OS-mode (On Sight mode) is a supervised driving mode offered to the onboard by the signalling system. OS-mode cannot be selected by the Driver.

OS-mode allows movements on an OS MA in situations where a track could be occupied by another train or any kind of obstacle.

The train is supervised to a maximum speed of 40 km/h, speed restrictions and a target distance.

### Responsibilities

OR.DEF.83

### Driver

You must observe the conditions of on sight as long as the symbol for OS-mode is shown on the DMI.



As long as the text message "Entering OS" is displayed on your DMI, you must observe any speed restrictions below 40 km/h related to the part of your train not yet covered by the OS MA. The speed must not exceed 25 km/h when the message is indicated while driving from a possession or shunting area.

OR.DEF.719

**Override end of authority**

OR.DEF.720

DEFINITION

The override end of authority symbol is indicated on the DMI when the Driver has used the override function

The override end of authority symbol always appears together with SR-mode. The symbol disappears once the end of authority has been passed. In case the train fails to pass the end of authority within 200 metres or 60 seconds of activating the override function, the onboard will enter TR-mode.

Responsibilities

OR.DEF.721

Driver

When the symbol for override end of authority is indicated on the DMI, you must be prepared to enter TR-mode if the train fails to pass the end of authority within 200 metres or 60 seconds of activating the override function.



OR.DEF.722

Driver

As long as the override end of authority symbol is indicated in the DMI, you must observe the speed of SR-mode and the condition of on sight.

OR.DEF.911

**Start of private infrastructure**

OR.DEF.912

DEFINITION

The marker "Start of private infrastructure" marks the beginning of private owned infrastructure.

The marker is placed in permanent shunting areas at the beginning of private owned infrastructure. The owner of the infrastructure is indicated on the marker.

Responsibilities

OR.DEF.914

Shunter

Before passing the marker, you must ensure that you are authorised to pass the marker by the owner of the infrastructure.



OR.DEF.915

**End of private infrastructure**

OR.DEF.916

DEFINITION

The marker "End of private infrastructure" marks the end of private owned infrastructure.

The marker is placed in permanent shunting areas at the beginning of infrastructure owned or managed by Banedanmark.

Responsibilities

OR.DEF.918

Shunter

You must pass the marker without further permission.



OR.DEF.195

**PT-mode**

OR.DEF.196

DEFINITION

The onboard enters PT-mode (Post Trip mode) when the Driver has acknowledged TR-mode. In PT-mode the emergency brake can be released. If the change to TR-mode is caused by an emergency stop the onboard will wait for the emergency stop to be revoked before the onboard can receive a movement authority.

The change to PT-mode is reported by the onboard to the signalling system.

Responsibilities

OR.DEF.197

**Driver**

When you have acknowledged TR-mode the symbol for PT-mode will be shown on the DMI and you must remain at standstill and inform the Signaller or Shunter.



OR.DEF.448

**SB-mode**

OR.DEF.449

DEFINITION

SB-mode (Standby mode) is the default standby mode of the onboard. SB-mode cannot be selected by the Driver but is entered automatically on closing the desk or exiting SH-mode.

Train awakening is performed from SB-mode. Onboard train data can be entered and updated by the Driver when in SB-mode.

In SB-mode, the train is supervised against runaway movements.

Responsibilities

OR.DEF.450

**Driver**

When the symbol on the DMI indicates the train is in SB-mode you must not attempt to move the train.

You may, however, move the train up to 1 metre in SB-mode when it is required for joining or splitting of the train.



OR.DEF.157

**SF-mode**

OR.DEF.158

DEFINITION

SF-mode (System Failure mode) is an onboard state that prevents any further movements using ETCS. It is entered automatically when the onboard detects a safety critical failure.

When the onboard equipment is in SF-mode, the emergency brakes are applied.

Responsibilities

OR.DEF.159

**Driver**

When the symbol indicating SF-mode is displayed on the DMI you must consider the onboard as failed.



OR.DEF.130

**SH-mode**

OR.DEF.131

**DEFINITION**

In SH-mode (Shunting mode) the onboard equipment supervises the train movements against a speed limit of 25 km/h.

SH-mode can be requested by the Driver, or ordered by the signalling system as part of a movement authority into a possession or shunting area.

If the train exceeds the SH-mode speed limit an automatic brake application will be applied.

The SH-mode does not require any onboard train data to be entered by the Driver.

**Responsibilities**

OR.DEF.700

**Driver**

If SH-mode is not ordered by the signalling system you may only request SH-mode by pressing the "Shunting" button on the DMI when instructed by the Shunter.

OR.DEF.132

**Driver**

When the symbol on the DMI indicates the train is in SH-mode you must observe the rules for shunting.

You must only move your train when authorised by the Shunter.



OR.DEF.138

**SH-mode refused**

OR.DEF.139

**DEFINITION**

When the request from a Driver of changing to SH-mode cannot be granted the signalling system will respond by refusing SH-mode.

**Responsibilities**

OR.DEF.140

**Driver**

When the text message "SH refused" is displayed on the DMI you must inform the Shunter about the situation.

OR.DEF.149

**SN-mode**

OR.DEF.150

**DEFINITION**

Running in SN-mode (STM National mode) enables ETCS equipped trains to use the STM to run on lines equipped with train control systems other than ETCS. Trains in SN-mode run in level ATC.

**Responsibilities**

OR.DEF.151

**Driver**

When the symbol for SN-mode is indicated on your DMI you must check that the mode is appropriate for your location and you must observe operational rules valid for the line concerned.



OR.DEF.146

## SR-mode

OR.DEF.147

### DEFINITION

SR-mode (Staff Responsible mode) is a driving mode used in degraded situations. SR-mode is selected by the Driver using the override function, or offered by the signalling system for the Driver to acknowledge.

SR-mode enables the train to move whenever a movement authority cannot be issued by the signalling system. The authority to select or acknowledge SR-mode can only come from the Signaller using an Operational Instruction.

Train movements are supervised to a maximum permitted speed of 40 km/h and against running in the direction opposite to the direction faced by the active desk.

### Responsibilities

OR.DEF.148

#### Driver

Before using the override function you must receive an Operational Instruction and check the applicable speed limit. Following the use of the override function the symbol for running in SR-mode is displayed on the DMI.



When driving in SR-mode you must observe the conditions of on sight.

OR.DEF.570

## Platform markers

OR.DEF.571

### DEFINITION

Platform markers are placed at different locations along, or after, the platform to assist the Driver of a passenger train in identifying the correct stopping location corresponding to the length of the train.

Two different platform markers exist:

- the metre marker
- the S marker

The metre marker indicates the optimum stopping location along a platform by numerical values denoting the length of the train.

The S marker indicates the stopping location for trains that are longer than indicated by the metre markers, or where no metre marker are present.

### Responsibilities

OR.DEF.572

Driver

When you approach a platform for the purpose of exchanging passengers, you must bring your train to a standstill at the correct stopping location as indicated by metre marker and rolling stock specific Railway Undertaking procedures.



OR.DEF.573

Driver

When you approach a platform for the purpose of exchanging passengers, with a train that is longer than indicated on the metre markers, you must bring your train to a standstill at the S marker according to rolling stock specific Railway Undertaking procedures.

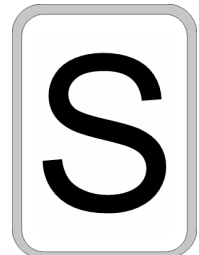

OR.DEF.593

## Electrical unit stop marker

OR.DEF.594

### DEFINITION

The electrical unit stop marker is a marker placed in the catenary system or at trackside to indicate to the Driver that from the location of the marker and beyond, the catenary power supply ends.

At locations with multiple directions, and one direction leads into a track without catenary power, the electrical unit stop marker is supplemented with an arrow indicating the direction to which the marker applies.

### Responsibilities

OR.DEF.601

#### Driver

You must as far as possible bring your electrical rolling stock to a standstill before any pantograph passes the electrical unit stop marker.



In case you identify that the pantograph(s) will pass the electrical unit stop marker, you must immediately lower the pantograph(s).

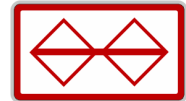

OR.DEF.905

#### Shunter

You must bring electrical rolling stock to a standstill before any pantograph passes the electrical unit stop marker.

In case you identify that the pantograph(s) will pass the electrical unit stop marker, you must immediately lower the pantograph(s).

OR.DEF.723

**Stop at danger point**

OR.DEF.724

**DEFINITION**

The "Stop at danger point" marker indicates the location where the train or vehicle must be stopped when no authority to move is given out of the area.

The marker is placed in permanent shunting areas in front of danger points located so close to routes or the like, that driving to the danger point indicated on the marker could cause a risk of coming into conflict with other routes, derailment or the like.

Train awakening is performed in front of the marker. There may be points located between the marker and the danger point indicated on the marker.

**Responsibilities**

OR.DEF.725

**Shunter**

When the train or vehicle does not have authority to move out of the area, you must ensure that it is stopped in front of the marker.

You must ensure that points between the marker and the danger point indicated on the marker are in the correct lie.



OR.DEF.460

**Start of ATC-signalling**

OR.DEF.461

**DEFINITION**

Start of ATC-signalling (Automatic Train Control) is a collective term of start of ATC-signalling and start of ATC-togstop-signalling.

The start of ATC-signalling is the location at which signalling is transferred to ATC-signalling.

**Responsibilities**

OR.DEF.462

**Driver**

When passing the location of the start of ATC-signalling marker you must observe operational rules for the level ATC area.



OR.DEF.707

**Driver**

When passing the location of the start of ATC-togstop-signalling marker you must observe operational rules for the level ATC area.



OR.DEF.464

**Signaller**

You must only coordinate train movements up to the start of ATC-signalling marker.

Authority over the transition area is shared between the Signaller and the Legacy signaller controlling the adjacent track sections.



OR.DEF.222

**Start of ETCS-signalling**

OR.DEF.223

DEFINITION

The start of ETCS-signalling is the location at which signalling is transferred from lineside signals to ETCS-signalling.

Responsibilities

OR.DEF.224

Driver

When passing the location of the start of ETCS-signalling marker you must observe ORF.



OR.DEF.226

Signaller

You must coordinate train movements from the start of ETCS-signalling marker.

Authority over the transition area is shared between the Signaller and the Legacy signaller controlling the adjacent track sections.

OR.DEF.217

**End of ETCS-signalling**

OR.DEF.218

DEFINITION

The end of ETCS-signalling is the location at which signalling is transferred from ETCS-signalling to level 0 and lineside signalling.

Responsibilities

OR.DEF.219

Driver

When passing the end of ETCS-signalling marker you must apply operational rules for the area you are entering.



OR.DEF.221

Signaller

You must coordinate train movements up to the end of ETCS-signalling marker.

Authority over the transition area is shared between the Signaller and the Legacy signaller controlling the adjacent track sections.

OR.DEF.896

**Start of ORS**

OR.DEF.897

DEFINITION

Start of ORS is the location at which rules for driving is transferred to ORS.

Responsibilities

OR.DEF.899

Driver

When passing the location of the "Start of ORS" marker, you must observe ORS.



OR.DEF.900

Signaller

You must coordinate operation up to the marker, "Start of ORS" with the Signaller on S-bane. Managing the area is split between the two Signallers operating the two neighboring lines.

OR.DEF.36

## Lower pantograph

OR.DEF.37

### DEFINITION

Lower pantograph marks the beginning of a lowered pantograph area. The pantograph(s) on an electric traction unit must be lowered for the train to safely travel through e.g. because there is a change of traction voltage supply.

These areas are indicated in the Route Book and defined in the signalling system.

The location of the lower pantograph area is indicated by marker boards and for supervised trains, also on the Drivers DMI.

### Responsibilities

OR.DEF.38

Driver

When the symbol for begin lowering pantograph is displayed on the DMI you must begin lowering the pantograph(s). The DMI will indicate the symbol in grey if lowering the pantograph(s) happens automatically.



OR.DEF.39

Driver

You must have the pantograph(s) lowered when the electrical rolling stock reaches the lower pantograph marker.

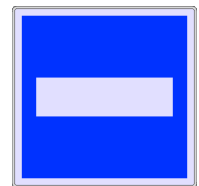
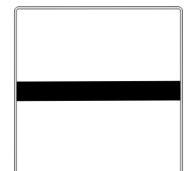

OR.DEF.47

## System electrical supply

OR.DEF.48

### DEFINITION

System electrical supply describes the power supplied by the overhead wire by indicating the voltage and frequency.

### Responsibilities

OR.DEF.49

Driver

You will encounter the system electrical supply marker when leaving a lowered pantograph area.

When your train reaches the system electrical supply marker you must only raise the pantograph(s) if your electrical rolling stock is capable of receiving the indicated power.

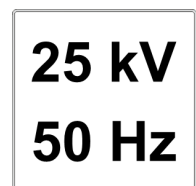

OR.DEF.188

**TR-mode**

OR.DEF.189

DEFINITION

TR-mode (Trip mode) is an irrevocable application of the emergency brakes by the onboard until the train is at a standstill and enters post trip. TR-mode is triggered by a failure, an attempt to pass an end of authority or by the Signaller applying an emergency stop.

The TR-mode removes the movement authority and the change to TR-mode is reported by the onboard to the signalling system.

Responsibilities

OR.DEF.190

**Driver**

When the symbol for TR-mode is displayed on the DMI you must assume that there is a dangerous situation. You must perform all actions necessary to avoid or reduce the effect of this situation.

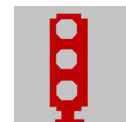

OR.DEF.227

**UN-mode**

OR.DEF.228

DEFINITION

Driving in UN-mode (Unfitted mode) is used for driving in an area not equipped with ETCS or ATC. Rules for driving in UN-mode are not contained in ORF.

UN-mode only supervises to a ceiling speed set to 120 km/h and is a driving mode used for driving in a level 0 area. UN-mode cannot be selected by the Driver but is entered during start of mission when level 0 is selected or following transition into a level 0 area.

Route book and location specific descriptions will give information on permissible speed limits.

Responsibilities

OR.DEF.229

**Driver**

You must control your train according to the operational rules of the level 0 area as long as you remain in the level 0 area. The symbol for UN-mode on the DMI indicates that only a ceiling speed of 120 km/h is supervised by the onboard.



OR.DEF.685

**Operational Instructions**

OR.DEF.233

## Operational Instruction

OR.DEF.234

### DEFINITION

An Operational Instruction is an instruction issued by the Signaller to the Driver to ensure safe operation when this cannot be provided by the signalling system.

An Operational Instruction must only be issued when the train is at a standstill and never past more than one ETCS stop marker at a time.

An Operational Instruction may be transmitted as verbal instructions for the driver to write down or handed out physically on paper to the Driver.

An Operational Instruction must not be transferred from one Driver to another Driver.

When an Operational Instruction has been issued it is valid until the movement is completed and the train has reached the end of authority, until it is revoked by an Operational Instruction 4, or a new Operational Instruction referring to the authorisation of the previous Operational Instruction using "Additional instruction".

Warning systems at passenger and staff crossings are not necessarily activated for driving on Operational Instructions.

An Operational Instruction will state:

- which train it is issued to
- the time and date it is issued
- location of train (if relevant)
- location of issuer
- a clear, precise, unambiguous instruction
- a Unique Identification.

Field C is filled when the position of the train is at a kilometer reference in a location with two or more tracks next to each other. The field is filled with kilometer and number of track.

### Responsibilities

OR.DEF.235

Driver

When you receive an Operational Instruction you must check that the Operational Instruction refers to your train and, if relevant, its current location.

OR.DEF.236

Driver

When you receive an Operational Instruction 1, Operational Instruction 2, Operational Instruction 3, Operational Instruction 4, Operational Instruction 5, Operational Instruction 6, Operational Instruction 7 or Operational Instruction 21, it takes precedence over other indications presented on the DMI except when a lower permitted speed or a lower release speed is displayed.

OR.DEF.237

Signaller

You must issue the Operational Instruction to be executed as close as sensible to the affected area and only when the necessary conditions are met.

OR.DEF.238

## Operational Instruction 1

OR.DEF.239

### DEFINITION

Operational Instruction 1 is a permission to pass an end of authority using either SR-mode or with isolated onboard. It is used when the signalling system cannot issue a movement authority.

In addition to the general information contained in an Operational Instruction, the Operational Instruction 1 also specifies:

- the end of authority that is allowed to be passed
- relevant speed restrictions below 40 km/h
- additional relevant instructions.

Additional relevant instruction is e.g. on a failed level crossing.

See Book of forms Operational Instruction 1 for layout.

OR.DEF.506

## Operational Instruction 2

OR.DEF.507

### DEFINITION

Operational Instruction 2 is a permission to proceed after an emergency stop. It is used when a train has entered TR-mode and necessary conditions for train movement to resume have been established.

If a train cannot resume driving on a movement authority after entering TR-mode, the Operational Instruction 2 also contain:

- permission to start in SR-mode
- relevant speed restrictions below 40 km/h
- instruction on specific observations to be made
- additional relevant instructions.

See Book of forms Operational Instruction 2 for layout.

OR.DEF.240

## Operational Instruction 3

OR.DEF.241

### DEFINITION

Operational Instruction 3 is an obligation to remain at a standstill.

Previously issued Operational Instructions must be revoked using the "Additional instructions" option.

When an Operational Instruction 3 is issued, the train is under obligation to remain at standstill until it is revoked by an Operational Instruction 4, or until it has been replaced by another Operational Instruction which explicitly refers to the issued Operational Instruction 3.

See Book of forms Operational Instruction 3 for layout.

OR.DEF.674

## **Operational Instruction 4**

OR.DEF.675

### DEFINITION

Operational Instruction 4 is a revocation of another Operational Instruction.

See Book of forms Operational Instruction 4 for layout.

OR.DEF.499

## **Operational Instruction 5**

OR.DEF.500

### DEFINITION

Operational Instruction 5 is an obligation to run with a speed restriction.

The Operational Instruction 5 may contain instructions on:

- speed restriction not supervised by the signalling system
- specific observations to be made
- additional relevant instructions.

See Book of Forms Operational Instruction 5 for layout.

OR.DEF.890

## **Operational Instruction 6**

OR.DEF.891

### DEFINITION

Operational Instruction 6 is an obligation to run on sight. In addition to the instruction to run on sight, the Operational Instruction 6 contains information about to whom to report any observations made while driving.

See Book of Forms Operational Instruction 6 for layout.

OR.DEF.576

## **Operational Instruction 7**

OR.DEF.577

### DEFINITION

Operational Instruction 7 is a permission to start in SR-mode after train awakening. It is used when the signalling system cannot issue a movement authority because the location status stored by the onboard is reported invalid or unknown.

In addition to the general information contained in an Operational Instruction, the Operational Instruction 7 specifies:

- the end of authority that is allowed to be passed
- permission to start in SR-mode
- relevant speed restrictions below 40 km/h
- additional relevant instructions.

See Book of forms Operational Instruction 7 for layout.

OR.DEF.548

## **Operational Instruction 22 - Request working unit movement form**

OR.DEF.549

### DEFINITION

Operational Instruction 22 is used for planning of movements with working units.

Part A contains the working unit data and is prepared by the Driver prior to contacting the Signaller. Part B is used to plan the schedule for the mission and is prepared by the Signaller based on the information provided by the Driver on part A.

See Book of forms, Operational Instruction 22, for layout.

OR.DEF.694

## **Failed Train**

OR.DEF.289

### **Disabled train**

OR.DEF.290

### DEFINITION

A disabled train is a train which cannot complete its mission because it is no longer safe and fit for service.

The responsible Railway Undertaking evaluates the failure on the disabled train to determine if it can be repaired at the site or moved by an assisting train.

OR.DEF.272

### **Assisting train**

OR.DEF.273

### DEFINITION

An assisting train is used to move another train if it is not able to continue by itself or to transfer passengers from a malfunctioning train or in the event of an incident.

Assisting trains are announced by the Network manager either by updating the signalling system with a new timetable, or changing the timetable of an existing train.

An assisting train runs according to a timetable. The assisting train will join/share the section with the failed train. The assisting train can be coupled to the front of the failed train or assist from the rear. Once the assisting train has been coupled to the failed train, the entire consist either continues with one of the existing train running numbers or becomes a new train with a new timetable.

OR.DEF.479

### **Failed train marking**

OR.DEF.480

### DEFINITION

The failed train marking is a signalling system function applied by the Signaller to the train running number of a failed train. Once applied, the signalling system will shorten any movement authority associated with the train.

When the failed train marking is activated, it is indicated to the Signaller on the signalling control display.

OR.DEF.305

**Isolate onboard**

OR.DEF.306

DEFINITION

Isolation of the onboard is done by the Driver when failures on the onboard prevents further movements with active onboard. When isolated the interface between the onboard and the brakes is completely bypassed.

Maximum permitted speed with isolated onboard is 40 km/h.

No indications are available on the DMI when the onboard is isolated.

Movements with isolated onboard are done as unsupervised movements authorised by the Signaller on an Operational Instruction or by the Shunter for shunting movements. Trains are only moved with isolated onboard as far as practicable and never as part of normal service.

Responsibilities

OR.DEF.307

**Driver**

When the onboard is isolated, you must only move your train according to Operational Instructions received from the Signaller, or according to authority provided by the Shunter.

When driving with isolated onboard you must observe the conditions of on sight.

OR.DEF.398

**Accidental division**

OR.DEF.399

DEFINITION

An accidental division is when unintentional splitting occurs and may be caused by faulty or insufficient train preparation or failures on a train.

OR.DEF.695

**Infrastructure**

OR.DEF.274

**Axle counter**

OR.DEF.275

DEFINITION

An axle counter is a device which is used, in connection with counting heads placed trackside, to detect railway movements in and out of an axle counter section.

An axle counter section can be indicated occupied, unoccupied or failed.

An axle counter section is proven unoccupied when a matching number of axles are counted in and out.

Following a miscount the axle counter section can be reset. A reset axle counter section will be cleared once a train or vehicle has passed through the axle counter section.

If the first train passing the axle counter section is supervised, the train will be restricted to an OS MA.



OR.DEF.874

**Track under Construction**

OR.DEF.875

DEFINITION

Track under construction is tracks that have not previously been attached to the operational railway. Rules for movements on tracks under construction is provided by the responsible for the track.

If work is to be performed closer to the operational railway than 4 m, this have to be done according to the rules in "Rules for working in infrastructure".

When a track under construction is connected to the operational railway this is done according to the engineering rules. Rules for movements between a track under construction and the operational railway is set out by the operational rules responsible.

OR.DEF.876

**Track under renewal**

OR.DEF.877

DEFINITION

Operational tracks that in a longer period is only to be used for infrastructure work can be track under renewal if the work in the relevant track is performed without the Signallers participation and the boundary to operational railway is clear according to the engineering rules for track under construction.

The operational rule responsible establishes when and under which conditions a track becomes track under renewal and determines the rules for movements between the track under renewal and the operational track.

OR.DEF.287

**Depot**

OR.DEF.288

DEFINITION

A depot is a non interlocked area of the infrastructure used for parking and/or maintenance of rolling stock. A depot is a permanent shunting area.

A single depot can have more than one point of entry and exit.

All depots are identified by a location name and these can be found in the route book.

OR.DEF.633

**Hand operated point**

OR.DEF.634

DEFINITION

A hand operated point can be manually thrown from one position to the other. Hand operated points are found in permanent shunting areas.

OR.DEF.892

**Main signal**

OR.DEF.893

DEFINITION

Main signal is the collective term used for trackside signals in level 0 or level ATC which can show a "Stop" aspect.

OR.DEF.536

## **User worked crossing**

OR.DEF.537

### DEFINITION

A user worked crossing is a private road or footpath crossing the railway. User worked crossings are protected by manually operated gates. The gates should only be opened by a member of public when authorised by the Signaller.

At a user worked crossing no technical installation to safeguard against railway movements exists.

Locations of user worked crossings can be found in the Route Book and are indicated on the signalling control display.

OR.DEF.878

## **Closed track**

OR.DEF.879

### DEFINITION

The Person responsible for technical operation can determine that a track for a longer period or permanently is closed for all driving and shunting and becomes a closed track. The Person responsible for technical operation informs The Person responsible for traffic operation.

The Person responsible for traffic operation ensures that:

- possible lock of points or other measure that prevents driving and shunting
- necessary announcement of the condition.

OR.DEF.469

## **Clamp**

OR.DEF.470

### DEFINITION

A clamp is the mechanical device used by competent maintainers and Drivers to prevent movement of the point. The clamp can be used to secure the closed switch rail (and the open switch rail after trailing) and allow movements to pass the point without risk. Clamps are also used during point renewal.

The clamp is always secured by a pin and can be supplemented with a padlock. Only maintainers with relevant education are permitted to mount a padlock to a clamped point.

OR.DEF.497

## **Trailing direction**

OR.DEF.498

### DEFINITION

The trailing direction through a point is the direction where the two routes through the point converge onto each other.

Passing a point not in the correct lie in the trailing direction will result in a trailing.

OR.DEF.481

## **Facing direction**

OR.DEF.482

### DEFINITION

Facing direction is the approach to a point from where it is possible to direct a movement in the right or left direction.

OR.DEF.606

## **Marker board**

OR.DEF.607

### DEFINITION

A marker board is placed in the infrastructure to provide information to staff.

Only marker boards defined in ORF are relevant to the operational railway.

Other marker boards can be found in the infrastructure. The layout of these marker boards does not resemble any of the marker boards defined in ORF. The location specific descriptions may contain information about the meaning of marker boards not defined in ORF.

OR.DEF.63

## **Neutral section**

OR.DEF.64

### DEFINITION

A neutral section is a section of the catenary system that electrically separates two supply areas. The location of neutral sections is indicated in the Route Book and is defined in the signalling system.

The location of the neutral sections is indicated by trackside marker boards and is displayed in the DMI for supervised trains.

OR.DEF.544

## **Bascule bridge**

OR.DEF.545

### DEFINITION

A bascule bridge is a low railway bridge, or a combined railway and road bridge, that can be elevated in order to allow the passage of ships. Railway traffic across the bridge is controlled by the Signaller.

Bascule bridges are locally operated by a Bridge guard.

The normal position for a bascule bridge is to allow for railway and road traffic. To allow ships to pass, or for maintenance purposes, the bascule bridge is requested released for operation by the Bridge guard.

OR.DEF.323

## Level crossing

OR.DEF.324

### DEFINITION

A level crossing is where a road and the railway intersect at the same level.

The position and the protection status of level crossings in interlocked areas, are indicated on the signalling control display. Controls are provided for the Signaller to operate the level crossing if needed.

The locations of level crossings in interlocked areas are indicated in the Route Book.

All level crossings can be operated from a local control box. The local control box is used in case of failures, fault correction or planned maintenance. The level crossing status "protected" is indicated by a light in the local control box.

### Responsibilities

OR.DEF.657

### Shunter

You must observe from the indication in the local control box that the level crossing is protected before authorising a shunting movement to pass a level crossing in a possession or temporary shunting area.

OR.DEF.320

## Parking track

OR.DEF.321

### DEFINITION

A parking track is a track in interlocked area designated for parking of rolling stock in-between missions. If a train is to end a mission at a parking track, this will be indicated in the production plan.

Sharing of track sections in a parking track is to be expected.

The location of parking tracks can be found in the Route Book.

### Responsibilities

OR.DEF.322

### Driver

When you are routed into a parking track in OS-mode you must always expect to be routed into an occupied track.

OR.DEF.410

**Passenger and staff crossings**

OR.DEF.411

DEFINITION

Warning systems exist at some staff crossings and passenger crossings, to provide a warning to passengers or staff crossing the track about approaching trains.

Passenger crossings indicates where passengers are permitted to cross the track to get to the opposite platform. For crossings equipped with a warning system, red warning lights and warning sound will warn the passengers about approaching trains. For crossings not equipped with a warning system, signs are placed to remind passenger to look for approaching trains.

Staff crossings are used by railway staff to use. Staff crossings can be provided with yellow flashing lights indicating to the railway staff that a train is approaching.

The warning system is not guaranteed to provide a warning and railway staff needs to be vigilant to approaching trains at all times.

A non activated warning system will be detected by the signalling system and a speed restriction of maximum 40 km/h will automatically be imposed at the crossing. The Driver will be informed via a text message which will be displayed along with the movement authority if a warning system is not activated. The signalling system will inform the O&M coordinator and the Signaller about failures in a warning system.

Responsibilities

OR.DEF.412

**Driver**

When passengers have to cross a passenger crossing to leave your train, or to get to it, you must be vigilant to other trains approaching the crossing and if necessary warn the passengers.

OR.DEF.706

**All**

You must be vigilant to approaching trains at all times, regardless of the indication of the warning system.

OR.DEF.282

**Correct lie**

OR.DEF.283

DEFINITION

Correct lie is when the position of the point blades corresponds with the intended direction.

The status of the points operated by the interlocking is indicated to the Signaller on the signalling control display.

OR.DEF.489

## **Protected level crossing**

OR.DEF.490

### DEFINITION

A level crossing is protected when the signalling system has received confirmation that protective devices have completed their sequence.

When a level crossing becomes protected this is indicated on the signalling control display.

Level crossings are protected by a combination of warning devices (sound and light) and barriers - if available - to warn users of an approaching train.

OR.DEF.530

## **Track section**

OR.DEF.531

### DEFINITION

A track section is a predefined part of the infrastructure limited by either two consecutive ETCS stop markers or by the system border and an ETCS stop marker.

One track section may include several axle counter sections.

OR.DEF.668

**Handheld terminal operated point**

OR.DEF.669

DEFINITION

Handheld terminal operated points can mark the entrance to a non interlocked area. The area behind the point is a permanent shunting area.

A handheld terminal operated point is protected by the signalling system in the correct lie to allow for supervised movements in the interlocked area.

The location of handheld terminal operated points is indicated in the Route Book and on the signalling control display.

In order to throw the point using the handheld terminal, the Signaller will establish a temporary shunting area or possession. In case the handheld terminal is not available, a handheld terminal operated point can be thrown by the Signaller, when a temporary shunting area is established.

When the point is thrown to allow driving into the permanent shunting area behind the point, the Shunter may authorise a shunting movement into the area without further permission from the Signaller.

Handheld terminal operated points can also be thrown by maintainer using a hand crank after permission from the Signaller.

Responsibilities

OR.DEF.670

**Signaller**

Before throwing a handheld terminal operated point from the Traffic control centre you must request the person requesting the throw of the point to do a visual inspection of the point to ensure that no rolling stock occupies the point.

OR.DEF.708

**Maintainer**

You must obtain permission from the responsible Signaller before using a hand crank to throw a handheld terminal operated point.

OR.DEF.709

**Signaller**

Before you permit a Maintainer to throw a handheld terminal operated point using a hand crank you must ensure that it is safe to do so.

OR.DEF.603

**Point position indicators**

OR.DEF.604

DEFINITION

Point position indicators are located at all points leading into a track area not equipped with catenary power.

A point position indicator shows the point position with a straight line if the point is for driving on the straightest branch. If the switch is not for driving on the straightest branch, it is shown with a slanted line.

If the point position indicator shows a yellow aspect it indicates entry to an area not equipped with catenary power.

Point position indicators are also installed at trap points and derailleurs.

A point position indicator at a trap points and derailer indicates with a horizontal black line whether the point must not be passed.

Responsibilities

OR.DEF.605

**Driver**

When you observe a yellow aspect on a point indicator and you are controlling electrical rolling stock, you must as far as possible bring your train to a standstill before the electrical unit passes the yellow aspect on a point indicator and inform the Signaller and Shunter.

In case you identify that the train will pass the yellow aspect on a point indicator, you must immediately lower the pantograph(s).

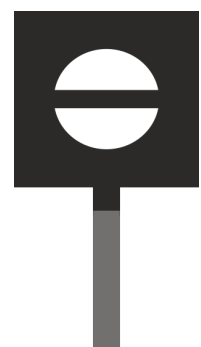
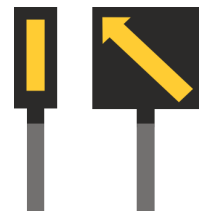
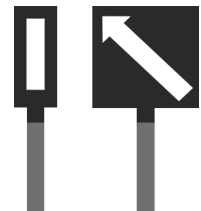

OR.DEF.647

**Shunter**

When you discover that the shunting movement is about to pass a point indicator that indicates that the point is not in the correct lie, you must immediately order the shunting movement to stop.

If the shunting movement passes a point indicator with a yellow display and you are controlling electrical rolling stock, you must inform the Driver to immediately lower all pantographs.



OR.DEF.701

**Buffer stop**

OR.DEF.702

DEFINITION

The buffer stop is placed at locations where the track terminates after the buffer stop. Buffer stops in interlocked areas can be equipped with an ETCS stop marker.

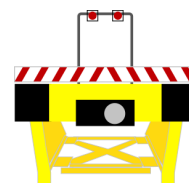

A buffer stop can be marked by red and white retro reflective markings and may be supplemented by two red light indications.

OR.DEF.627

**Interlocked point**

OR.DEF.628

DEFINITION

An interlocked point is a point controlled by the signalling system.

Interlocked points can be thrown by the Signaller via the signalling system, via a handheld terminal controlling a temporary shunting area or possession or by a maintainer using a hand crank.

When an area has been released for shunting/possession the points within the area can be thrown by use of handheld terminal.

Responsibilities

OR.DEF.629

**Maintainer**

You must obtain permission from the responsible Signaller before using a hand crank to throw an interlocked point.

OR.DEF.630

**Signaller**

Before you permit a Maintainer to throw an interlocked point using a hand crank you must ensure that it is safe to do so.

OR.DEF.608

**Operational railway**

OR.DEF.609

DEFINITION

The operational railway is where normal train and vehicle movements are performed and it includes interlocked areas and permanent shunting areas.

OR.DEF.534

**Tunnel protection system**

OR.DEF.535

DEFINITION

Tunnel protection system is the collective term used for hot axle box detection, and derailment detection placed at the approach to specific tunnels.

Trains passing the tunnel protection system will be checked against a predefined set of tunnel values. If a train exceeds the values, an alarm is indicated to the Signaller on the signalling control display. The alarm triggers an automatic response by the signalling system. The automated response is described in the location specific descriptions.

Locations of tunnel protection systems can be found in the Route Book.

OR.DEF.696

## Infrastructure Conditions

OR.DEF.26

### Low adhesion

OR.DEF.27

#### DEFINITION

Reduced friction between rails and wheels, caused by e.g. leaf fall. This may lead to the braking distance of trains and vehicles being extended due to slide, or slip being experienced when accelerating.

OR.DEF.107

### Unannounced data radio hole

OR.DEF.108

#### DEFINITION

An unannounced data radio hole is an area of poor data radio coverage. When a train encounters an unannounced data radio hole, a timer will be triggered in the onboard. After 45 seconds, the symbol for data radio communication failure will be displayed to the Driver in the DMI. Following another 5 seconds (total of 50 seconds), the onboard will automatically perform a brake intervention until the train is at a standstill, or data radio communication has been restored. A text message will be displayed to the Driver on the DMI when the brake intervention occurs.

#### Responsibilities

OR.DEF.109

Driver

When at a standstill with the text message "Communication error", and/or the data radio communication failure symbol, displayed on the DMI, you must contact the Signaller.

OR.DEF.663

Driver

In case the text message "Communication error", and/or the data radio communication failure symbol disappears from the DMI, and a movement authority is available, you may continue driving.

In case the text message "Communication error", and/or the data radio communication failure symbol disappears from the DMI, and no movement authority is available, you must contact the Signaller.

OR.DEF.301

**Unplanned speed restriction**

OR.DEF.302

**DEFINITION**

For supervised trains an unplanned speed restriction is a speed restriction not yet supervised by the signalling system. Supervised trains inside or entering an area with an unplanned speed restriction are brought to a standstill until such time that the speed restriction is updated in the signalling system.

For unsupervised trains an unplanned speed restriction is an immediate speed restriction lower than 40 km/h not contained on an Operational Instruction. The trains are brought to a standstill, and the Drivers are informed about the unplanned speed restriction by the Signaller issuing a new Operational Instruction.

An unplanned speed restriction becomes a temporary speed restriction when it is updated in the signalling system.

**Responsibilities**

OR.DEF.514

**Signaller**

You must only allow a supervised train to pass an unplanned speed restriction if a temporary speed restriction cannot be created due to operational restrictions.

OR.DEF.483

**Location specific description**

OR.DEF.484

**DEFINITION**

The location specific description is a supplement to ORF.

Location specific descriptions contain the additional instructions necessary for day to day operation at specific and defined geographical locations. The location specific descriptions will only be necessary for persons operating within the defined geographical locations.

OR.DEF.386

**Undetected point**

OR.DEF.387

**DEFINITION**

A point is undetected if the signalling control display does not indicate the point in the left or the right position.

An undetected point is not safe to pass by any train or vehicle unless precautions are taken.

OR.DEF.366

**Temporary speed restriction**

OR.DEF.367

DEFINITION

A temporary speed restriction is a speed restriction implemented in the signalling system used to reduce the speed of trains. Temporary speed restrictions can be used to protect people, trains or infrastructure.

A temporary speed restriction is planned and supervised by the signalling system.

A temporary speed restriction that is active is indicated on the signalling control display and on the onboard DMI.

Information about temporary speed restrictions relevant to unsupervised movements are provided to the Driver by the Signaller or Shunter.

Responsibilities

OR.DEF.368

Signaller

You must provide the Driver of an unsupervised movement with information of temporary speed restrictions below 40 km/h for the location where movements are authorised.

OR.DEF.369

Signaller

You must inform the Shunting area manager of temporary speed restrictions below 25 km/h inside a possession or temporary shunting area, and the Shunter if the speed restriction applies in a part of a route for shunting.

OR.DEF.370

Shunter

You must provide the Driver of a shunting movement with information of temporary speed restrictions below 25 km/h for the location where movements are authorised.

OR.DEF.371

**Trailed point**

OR.DEF.372

DEFINITION

When a train or vehicle is travelling through a point not in the correct lie in the trailing direction, the point is forced out of position and called trailed. When a point is trailed it is considered as damaged and no trains or vehicles are permitted to pass before the point has been inspected by a technician.

A record of trailed points is kept in the Signaller log.

Responsibilities

OR.DEF.373

Driver

If you trail a point you must bring the train or vehicle to a standstill and inform the Signaller.

OR.DEF.374

Signaller

You must ensure that no train or vehicle has authority to pass a reported trailed point until it has been inspected and released for driving by a Maintainer.

OR.DEF.297

**Electrical rolling stock restriction**

OR.DEF.298

DEFINITION

An electrical rolling stock restriction is an indication on the signalling control display which is activated in the relevant catenary sections when a catenary isolation or emergency catenary isolation is established and means, that electrical rolling stock must not be given authority to move into the isolated area.

The Signaller is responsible for maintaining the electrical rolling stock restriction during the catenary isolation or emergency catenary isolation.

Responsibilities

OR.DEF.903

**Signaller**

You must ensure that the electrical rolling stock restriction is maintained for as long as the power is isolated, and by doing so, ensuring that electrical rolling stock is not unintentionally moved into the isolated area.

OR.DEF.904

**Signaller**

Before issuing an authority to move into an isolated area, you must contact the Driver or Shunter to confirm that it is not electrical rolling stock.

OR.DEF.671

**Sanding**

OR.DEF.672

DEFINITION

Sanding is the process of applying sand directly to the rail using train borne equipment with the purpose of increasing the friction between the wheel and rail in situations of low adhesion.

Sanding should be performed to reduce the risk of an incident or accident from occurring.

Responsibilities

OR.DEF.673

**Driver**

You must as far as possible avoid sanding:

- in points or crossings
- while braking at speeds below 20 km/h
- when at a standstill.

OR.DEF.358

**Snow clearing train**

OR.DEF.359

DEFINITION

A snow clearing train is a train with snow ploughs coupled to it in each end which is scheduled to remove snow from the tracks.

The snow clearing train is driven as supervised movements in FS-mode or OS-mode.

A train running supervised on the line, without snow ploughs coupled to it, for the purpose of keeping the tracks open for operations is not considered a snow clearing train.

OR.DEF.419

**Clamped point**

OR.DEF.420

**DEFINITION**

Mechanically securing the point against throwing in a preferred lie using one or more clamps.

Clamping points is a temporary arrangement used in operations for undetected or traileed points. The clamp is secured by a locking pin to prevent unintended removal.

All interlocked points have fixed clamps fitted, usually found at the second sleeper from the blade tip

Drivers will only apply a clamp to the closed switch rail of an undetected point that has not been damaged and has to be passed in a facing direction. Damaged points will be clamped only by a maintainer after inspection.

The clamp is also used by a maintainer in case of limitations in the use of the point. When a point is clamped by a maintainer, the point is secured by a padlock.

Clamped points are indicated on the signalling control display once information has been updated into the signalling system.

**Responsibilities**

OR.DEF.421

**Driver**

When you are instructed by the Signaller to clamp the closed switch rail of a facing point you must apply the fixed clamp to the appropriate point.

OR.DEF.660

**Maintainer**

In an interlocked area you must only clamp a point once this is agreed with the Signaller.

OR.DEF.394

**Wind restrictions**

OR.DEF.395

**DEFINITION**

A wind restriction is applied to specific trains at specific locations, in the event of high wind speed.

Wind restrictions can be applied at areas described in location specific descriptions.

The wind restriction in the form of temporary speed restriction or line closure is implemented to mitigate risks caused by incidents such as swinging overhead wires or the instability of wind sensitive freight wagons.

OR.DEF.684

**Catenary**

OR.DEF.473

**Earthing**

OR.DEF.474

**DEFINITION**

Earthing is the operation of placing a conductive connection between the normally live parts of the catenary system and an earthing point. This ensures that any voltage present in the isolated catenary section, is limited to a safe level as well as protect persons working on or near the catenary system if voltage is conducted into the work area.

OR.DEF.276

**Catenary isolation**

OR.DEF.277

DEFINITION

A catenary isolation is shutting off power to one or more catenary sections.

A catenary isolation does not necessarily require a possession. A catenary isolation only affects electrical rolling stock, diesel powered rolling stock may continue running.

OR.DEF.467

**Catenary management system**

OR.DEF.468

DEFINITION

The catenary management system is an independent system used by the Catenary manager to control and monitor the operating and switching mode of the catenary system on the parts of the Banedanmark network that is electrified.

OR.DEF.714

**Broken or hanging overhead wires**

OR.DEF.715

DEFINITION

A broken or hanging overhead wire is when the wire has been completely or partially torn down.

It is extremely dangerous to:

- come closer than 5 metres to broken or hanging overhead wires
- touch any items or tools in contact with the wire
- leave a train at standstill close to broken or hanging overhead wires.

Whenever a broken or hanging overhead wire is observed it is reported to the Signaller immediately. The report contains information about:

- affected track(s) and area(s)
- what has happened
- potential danger to passing trains
- any precautions made to prevent accidents and damages.

Responsibilities

OR.DEF.716

All

You must never come closer than 5 metres to a broken or hanging overhead wire.

You must never touch any item or tool in contact with a broken or hanging overhead wire.

OR.DEF.717

Driver

In case the train is at standstill close to broken or hanging overhead wires, you must as far as possible ensure that passengers only leaves the train when the catenary staff or the Emergency services have secured the system.

OR.DEF.718

All

You must report broken or hanging overhead wires to the Signaller immediately.

OR.DEF.280

**Emergency catenary isolation**

OR.DEF.281

DEFINITION

An emergency catenary isolation is implemented immediately to reduce danger to people and damages on infrastructure or environment. An emergency isolation may be automatically invoked by the catenary system or manually by the Catenary manager.

OR.DEF.278

**Planned catenary isolation**

OR.DEF.279

DEFINITION

A planned catenary isolation is produced in advance by the Banedanmark Catenary planning department.

Details of planned catenary isolations are available as individual catenary isolation documents with a unique ID number.

OR.DEF.686

**Driving**

OR.DEF.546

**Working unit**

OR.DEF.547

DEFINITION

A working unit is a single traction unit used by track workers for maintenance or renewal of the railway network.

Working units are equipped with an onboard system and run according to the rules of a train.

OR.DEF.31

**Balise read error**

OR.DEF.32

DEFINITION

A balise read error occurs when the onboard is not able to use the messages contained in a balise or the balise is not read in the expected location.

A balise read error may trigger a brake intervention, and will automatically report the balise read error to the signalling system.

Responsibilities

OR.DEF.33

**Driver**

When the text "Balise read error" is displayed on the DMI and the onboard automatically performs a brake intervention, you must contact the Signaller when the train has reached a standstill.

OR.DEF.360

**Splitting**

OR.DEF.361

DEFINITION

Splitting is when a train is physically separated into two or more trains.

Splitting can be performed anywhere on the network.

Splitting one train into two trains on the move is permitted when trains are equipped with a technical system ensuring that the rear part is emergency braked to a standstill immediately after splitting. Railway Undertaking procedures prevent collision between rear and forward part.



OR.DEF.1

**DMI**

OR.DEF.2

DEFINITION

The DMI (Driver Machine Interface) is a screen that is a part of the onboard train control system. The DMI is installed in the Driver's desk to enable communication between the train control system and the driver.

The DMI indicates to the Driver the necessary signalling information to allow for supervised train movements.

For fully supervised movements the DMI will display an authority to move. For all other movements the DMI will display the driving mode indicating to the Driver under which conditions the train must be driven.

Responsibilities

OR.DEF.3

**Driver**

You must observe information displayed on the DMI and react as instructed in ORF. You must control the speed of the train to the lowest permissible speed, taking into consideration the information provided on the DMI and any other restrictions from persons authorising the movement or from location specific restrictions.

You must consider a failed DMI or an unreadable DMI as a failure in the onboard train control system.

If you have reason to believe that the information displayed on the DMI is faulty or not intended for your train, you must bring the train to a standstill and contact the Signaller.

OR.DEF.382

**Unsupervised movements**

OR.DEF.383

DEFINITION

Unsupervised movements can be performed by trains in SR- and SH-mode, with isolated onboard or vehicles performing shunting movements inside a possession, permanent shunting area or temporary shunting area.

There is no technical supervision preventing the train from overrunning the end of authority, or a vehicle overrunning the limits of the shunting movement. Furthermore, there is no technical supervision preventing the train or vehicle from exceeding temporary speed restrictions.

Responsibilities

OR.DEF.384

**Driver**

You are responsible for ensuring that your train or vehicle does not enter into an area where you are not authorised.

OR.DEF.385

**Driver**

You are responsible for ensuring that your train or vehicle does not exceed the maximum permitted speed.

OR.DEF.313

## Unplanned joining

OR.DEF.314

### DEFINITION

Unplanned joining is when the Drivers concerned have not been pre-informed about the joining through the timetable.

### Responsibilities

OR.DEF.315

### Signaller

You must inform the Drivers concerned if an unplanned joining is necessary before setting the route into the occupied track section.

OR.DEF.390

## Vehicle

OR.DEF.391

### DEFINITION

A vehicle can be driven and consists of one or more units of rolling stock not fitted with an onboard. Vehicles may only be moved inside possessions or shunting areas.

A vehicle is called a road railer if it can run on both rails and road. When a road railer is put on the tracks, it must always be within possessions or shunting areas.

OR.DEF.919

## Observations during driving

OR.DEF.920

### DEFINITION

Observations during driving are the term for the observations that the Driver must always do while driving.

The Driver must observe

- the condition of the infrastructure
- other trains and vehicles
- other conditions that may affect the operation.

If other staff are in the cab with the Driver, they must also observe while driving.

### Responsibilities

OR.DEF.922

While driving, you must observe the condition of the infrastructure, other trains and vehicles, and other conditions that may affect operations.

OR.DEF.923

If you observe something while driving that may pose a danger to your train or vehicle, you must immediately reduce your speed according to the conditions, or if necessary, stop your train or vehicle and notify the Signaller.

OR.DEF.924

If you stop your train or vehicle because you observe faults in the catenary system, you must immediately lower all pantographs and inform the Signaller.

OR.DEF.925

If you observe conditions while driving that may affect railway safety or operations, you must immediately notify the Signaller.

OR.DEF.291

## Driver ID

OR.DEF.292

### DEFINITION

A Driver ID is a unique identifier for every Driver.

The Driver enters Driver ID into the onboard before each mission. This is used to identify the Driver responsible for operating the train.

### Responsibilities

OR.DEF.293

### Driver

You must enter the Driver ID assigned to you when requested by the onboard.

You must ensure that the Driver ID is always updated on the onboard when you assume responsibility of a train.

OR.DEF.508

## Sound signal "Warning"

OR.DEF.509

### DEFINITION

Sound signal "Warning" is an acoustic signal performed by the Driver using the train horn.

"Warning" consists of a single long blast of the train horn.

### Responsibilities

OR.DEF.510

### Driver

You must use sound signal "Warning" if:

- you want to warn persons walking about in or near the tracks,
- persons are crossing the track on a passenger crossing in front of a moving train or vehicle.

OR.DEF.710

## Release speed

OR.DEF.711

### DEFINITION

Release speed is the speed where the onboard releases the train from the braking curve to allow the train to approach the ETCS stop marker at the end of authority.

When the DMI indicates a release speed the Driver is responsible for ensuring that the train does not pass the ETCS stop marker indicating the end of authority.

Release speed is indicated in the DMI by a grey marking on the speedometer and a specification of the release speed.

### Responsibilities

OR.DEF.712

### Driver

When release speed is indicated on the DMI, you must ensure that the train does not pass the ETCS stop marker at the end of authority.

OR.DEF.485

**Onboard**

OR.DEF.486

DEFINITION

Onboard is the collective term used when referring to the parts of the ETCS train control system that are fitted onto the train.

The parts of the ETCS train control system fitted on to the train are the:

- DMI
- European Vital Computer (EVC)
- balise reader
- antenna
- train interface unit
- juridical recorder
- odometry.

OR.DEF.380

**Supervised movements**

OR.DEF.381

DEFINITION

A supervised movement is a train running in FS- or OS-mode with the Driver controlling the train from the cab in the front end of the train (snow clearing trains excepted).

A supervised movement provides the onboard with information used to control the speed and distance to an end of authority.

Responsibilities

OR.DEF.872

**Driver**

You must only perform supervised movements in FS and OS-mode from the cab in the front end of the train.

OR.DEF.413

**Parking**

OR.DEF.414

DEFINITION

Parking is when rolling stock is left unattended by staff. Parked rolling stock is secured in a safe way to avoid unintentional movements.

In interlocked area parking is only permitted when pre-planned or agreed with the Signaller.

Responsibilities

OR.DEF.415

**Driver**

Before leaving rolling stock unattended you must ensure the rolling stock is secured according to procedures from the Railway Undertaking to prevent unintentional movements.

OR.DEF.416

**Driver**

You must ensure that the rolling stock is parked within the area of the fouling point(s) concerned.

OR.DEF.144

**Passenger train**

OR.DEF.145

DEFINITION

A train is a passenger train for the part of a mission for which the train is scheduled to carry passengers.

OR.DEF.362

**Planned splitting**

OR.DEF.363

DEFINITION

A planned splitting is when the splitting is done according to the timetable.

OR.DEF.311

**Planned joining**

OR.DEF.312

DEFINITION

A planned joining is when joining is performed according to the timetable and both Drivers has been informed in advance.

For planned joining, normal route setting is used up to the limit of the track section occupied by the stationary train. Driving into the occupied track section is done on an OS MA in OS-mode.

OR.DEF.353

**Scheduled stopping location**

OR.DEF.354

DEFINITION

A scheduled stopping location is a location where the train has to stop according to the timetable.

Scheduled stopping locations are divided into non-technical and technical stops.

Non-technical stops are as follows:

- passenger exchange
- freight preparation/wagon exchange
- Driver relief.

Technical stops are as follows:

- meet and cross
- overtaking
- capacity issues.

OR.DEF.84

**On sight**

OR.DEF.85

DEFINITION

On sight is restricted running with a maximum permissible speed of 40 km/h.

The track ahead could be occupied by another train or any other obstacle.

The Driver observes the conditions of on sight when instructed by the driving mode or when instructed by the Signaller.

Responsibilities

OR.DEF.86

**Driver**

You must check track occupancy when moving your train and be prepared to stop short of any train or other obstacle.

You must drive your train according to the conditions observed and not exceed 40 km/h.

You must report any unexpected observations to the Signaller.

OR.DEF.308

## Joining

OR.DEF.309

### DEFINITION

Joining is bringing two trains into the same track section for the purpose of coupling them into one train.

Joining is performed with only one train moving and the other train at a standstill.

### Responsibilities

OR.DEF.310

### Driver

When joining you must control the movement of your train to avoid causing damage to either trains.

OR.DEF.528

## Start button

OR.DEF.529

### DEFINITION

The Start button is available to the Driver on the DMI. Selecting the Start button will request a movement authority from the signalling system.

OR.DEF.664

**Test train**

OR.DEF.665

DEFINITION

A test train is used to test infrastructure or rolling stock.

A test train does not carry passengers.

The train radio or Driver's mobile phone is functioning and active.

Prior to running a test train, Banedanmark will issue a plan for performing the test and produce necessary instruction to all staff involved. The plan is produced in close cooperation with relevant Railway Undertakings. This planning includes e.g.:

- relevant permissions
- relevant dispensations
- necessary safety precautions to ensure the safety of the test train and the infrastructure
- if the test train is driving without an active onboard
- person responsible for executing the test.

Before starting the test train mission, all involved staff is thoroughly instructed about the test.

Location specific descriptions may contain supplementary requirements for the railway line concerned.

Location specific descriptions may contain predefined permissions and/or dispensations.

Responsibilities

OR.DEF.666

**Signaller**

You must ensure that the Driver is informed of relevant temporary speed restrictions if the test train is running without an active onboard.

OR.DEF.667

**Driver**

You must ensure that all staff involved in test train mission is thoroughly instructed about the test before starting the mission.

You must ensure that the Signaller is informed about your mobile telephone number in case the test train does not have a functioning and active train radio.

You must respect all speed restrictions during the test run.

During the test run, you must only perform tasks related to driving the test train and the communication associated with driving the test train.

OR.DEF.552

## Backwards movement

OR.DEF.553

### DEFINITION

A backwards movement is to intentionally move the train in the opposite direction to the active desk. Backwards movements are used in case a train has overrun a stopping location, or has mistakenly been routed in the wrong direction.

Backwards movements are only used when it is not possible to drive the train from the forward facing cab of the movement.

Passenger trains do not perform backwards movements.

Backwards movements are normally performed in SH-mode, but may in special cases be performed with an isolated onboard if the Driver has been forced to isolate the onboard.

A backwards movement is performed when the Driver remains in the lead cab and receives authority from the Signaller by the use of Operational Instruction 21.

See Book of forms, Operational Instruction 21, for layout.

OR.DEF.471

## Coupling

OR.DEF.472

### DEFINITION

Coupling is physically connecting trains or vehicles together. Wagons are also coupled to form part of a train or vehicle consist.

OR.DEF.378

## Train

OR.DEF.379

### DEFINITION

A train is rolling stock formed into a train consist. To qualify as a train, the train consist must be fitted with an onboard.

Trains can be supervised to move by the signalling system, or move unsupervised according to procedures.

OR.DEF.676

## Train horn

OR.DEF.677

### DEFINITION

Train horn is an audible warning device to be used by the Driver to warn persons in or near the tracks.

All trains have functioning train horn. In case a train horn fails during a mission, the maximum permitted speed is 40 km/h.

### Responsibilities

OR.DEF.678

#### Driver

If the train horn fails during a mission, you must ensure the speed of the train does not exceed 40 km/h and the Signaller is informed.



OR.DEF.185

**Train running number**

OR.DEF.186

DEFINITION

The train running number is a number used to identify a train on a specific mission.

A Driver attempt to duplicate a train running number already in use will trigger a warning on the signalling control display to the Signaller, and a text message in the DMI to the Driver.

The train running number is defined by the timetable.

Responsibilities

OR.DEF.642

**Driver**

You must keep the train running number updated in the onboard and train radio according to the timetable.

OR.DEF.697

**Level Transition**

OR.DEF.427

**Level 0**

OR.DEF.428

DEFINITION

Level 0 is the name given to an area of track that is not controlled by ETCS or ATC trackside equipment. The rules for driving in a level 0 area are not contained in ORF.

Level 0 may be used by working units performing shunting movements past the system border to the level 2 area between possessions in the transition area provided that the onboard is in SH-mode and the working unit does not leave the possession.

OR.DEF.841

**Level 1**

OR.DEF.844

DEFINITION

Level 1 is the name given to areas of track where ETCS is an overlay to the existing signalling systems, and signalling aspects are indicated to the Driver via the DMI in combination with lineside signals.

Level 1 is not used on the infrastructure managed by Banedanmark.

OR.DEF.429

**Level 2**

OR.DEF.430

DEFINITION

Level 2 is the name given to an area of track that is fitted with ETCS trackside equipment and signalling information is transmitted to trains via a radio link and displayed to the Driver on the DMI.

OR.DEF.155

**Level ATC**

OR.DEF.156

DEFINITION

Level ATC is the level where the Danish transmission module is translating information from train control systems other than ETCS. This will enable an ETCS equipped train to use this information to perform the train supervision functions of the Danish legacy train control system.

OR.DEF.198

## Level transition

OR.DEF.199

### DEFINITION

Level transition is the means by which a train can be controlled between areas of different train control systems and associated operational rules.

The locations of level transitions are indicated in the route book, defined in the signalling system and are indicated by markers at the trackside.

OR.DEF.501

## System border

OR.DEF.502

### DEFINITION

The system border is the location in the infrastructure marking the changeover in responsibility between the two neighbouring infrastructure areas with different signalling systems and operational rules.

The system border is marked in the infrastructure by a Start of ETCS-signalling marker, an End of ETCS-signalling marker, a Start of ATC-signalling marker or a Start of ATC-togstop-signalling marker.

The location of system borders can be found in the Route Book.

OR.DEF.550

## Transition area

OR.DEF.551

### DEFINITION

The transition area is a collective term used for the area of infrastructure where signalling responsibility is shared between two different infrastructure systems, e.g. cab-signalling and lineside signalling.

The system border is found within the transition area.

The transition area extends from the last ETCS stop marker and to the first main signal, or vice versa.

OR.DEF.693

## Emergency/incident

OR.DEF.578

### Hazardous area

OR.DEF.579

#### DEFINITION

A hazardous area is a dynamically assessed area of the infrastructure that based on any available information is identified as not safe, or potentially not safe, for railway movements.

Entering or moving within a hazardous area increases the risk of harm to people, environment, infrastructure or rolling stock.

It can be necessary to authorise a train or a vehicle to leave the hazardous area, if staying inside the hazardous area, is considered to pose a threat larger than the risk of leaving.

#### Responsibilities

OR.DEF.580

#### Signaller

You must as far as possible control train and vehicle movements to avoid entry into a hazardous area.

OR.DEF.656

#### Signaller

You must determine if it is safe for trains or vehicles inside the hazardous area to remain inside the area.

If you determine that it is not safe to stay inside the area, you must use all available means to ensure, that all trains or vehicles to leave the area.

OR.DEF.564

### Incident

OR.DEF.565

#### DEFINITION

An incident is a sudden and unplanned event causing, or threatening to cause, an interruption to the service and/or may pose a danger to the safety of the railway, people, property or the environment.

OR.DEF.566

**Incident investigation**

OR.DEF.567

**DEFINITION**

Incident investigation is when it has been decided that the Accident Investigation Board or the Banedanmark Incident investigator will do an investigation of the circumstances related to an incident.

Part of the incident investigation is to record the state of all systems and infrastructure elements prior to, and at, the time of the incident in order to establish the cause of the incident.

When it is decided to perform an incident investigation the equipment, systems and infrastructure elements involved are not to be operated, and related items are not be changed or removed.

**Responsibilities**

OR.DEF.568

**Signaller**

When an incident has called for an investigation, you must only operate the signalling system in the area concerned for the purpose of preventing further harm to persons, rolling stock or infrastructure, or if authorised by the Banedanmark Incident investigator.

OR.DEF.569

**Driver**

When an incident has called for an investigation, you must only operate the train or vehicle for the purpose of preventing further harm to persons, rolling stock or infrastructure, or if authorised by the Banedanmark Incident investigator.

OR.DEF.299

**Emergency brake**

OR.DEF.300

**DEFINITION**

Emergency brakes are the elements of the braking system that provide maximum braking force, and can be initiated by the Driver or automatically by the onboard. The emergency brake cannot guarantee that the train will always stop within a safe distance.

OR.DEF.477

**Emergency situation**

OR.DEF.478

**DEFINITION**

An emergency situation is an incident that poses an immediate risk to health, life, property or environment.

The fundamental reaction to an emergency situation is:

1. Stop the incident (from evolving), without jeopardizing oneself as a secondary victim,
2. Call for appropriate assistance
3. Provide life saving first aid.

OR.DEF.475

**Emergency services**

OR.DEF.476

**DEFINITION**

Emergency services are a collective term for the emergency response services including Police, Fire Fighting and Ambulance services.

OR.DEF.687

## Preparing a mission

OR.DEF.848

## Brake class

OR.DEF.849

### DEFINITION

The air pressure braking system is divided into three brake classes:

- R-brake (powerful and quick-acting)
- P-brake (quick-acting)
- G-brake (slow-acting).

OR.DEF.515

## Hazardous goods

OR.DEF.516

### DEFINITION

Dangerous goods is the term for substances and objects listed in the "Reglement for national og international befording af farligt gods med jernbane (RID)".

The individual substances and objects are identified by a UN number and a classification that indicates the properties of the goods. Furthermore, the term high-risk goods is used for dangerous goods that can be misused in a terrorist situation.

Hazardous goods are not transported by passenger trains.

OR.DEF.860

## G-brake

OR.DEF.861

### DEFINITION

Trains which are braked only by the G-brake, or a combination of the P-brake and G-brake where the G-brake weight is more than 10 % of the total brake weight of the train, are defined as G-braked.

For trains where the G-brake weight is more than 10 % of the train's total brake weight, all wagons and traction units are as far as possible set to G-brake.

The brake on working traction units are set to G-brake if the train length is more than 600 metres and/or the train weight is more than 800 tonnes.

### Responsibilities

OR.DEF.863

#### Driver

You must ensure that the all wagons and traction units are as far as possible set to G-brake when the G-brake weight is more than 10 % of the total brake weight of the train.

OR.DEF.864

#### Driver

You must ensure that the brake of working traction units are set to G-brake when the train length is more than 600 metres and/or the train weight is more than 800 tonnes.

OR.DEF.453

## Valid position

OR.DEF.454

### DEFINITION

A valid position is when the position stored by the onboard can be validated by the signalling system.

Without a valid position a train cannot enter FS- or OS-mode.

OR.DEF.176

## Railway undertaking train data

OR.DEF.177

### DEFINITION

Railway Undertaking train data supplements onboard train data and consists of mandatory and optional elements. Railway Undertaking train data is send to the traffic management system by the Railway Undertaking responsible for the specific train.

Mandatory Railway Undertaking train data is:

- hazardous goods information
- train consists (for freight trains).

Mandatory Railway Undertaking train data is always required by the traffic management system - even if the report is empty, as this confirms that no special conditions apply. The traffic management system uses mandatory Railway Undertaking train data to evaluate compatibility between train and route.

Optional Railway Undertaking train data is:

- Driver mobile phone number
- train consists (for passenger trains).

### Responsibilities

OR.DEF.178

#### Driver

You must only start running when you have confirmation that updated mandatory Railway Undertaking data has been supplied to the Infrastructure Manager at start of mission. And you must only restart running from a location where any of the previously supplied mandatory Railway Undertaking train data has changed when you have confirmation that the updated data has been supplied to the Infrastructure Manager.

OR.DEF.635

**Front end indication**

OR.DEF.636

**DEFINITION**

The front end of a train or vehicle is indicated with three white lights in an isosceles triangle. The front end indication are always lit and must be displayed with the strongest possible light when the train is being driven from that end.

For trains and vehicles without three working headlights, the front end of the train or vehicle can be indicated by two white lights.

For propelling locomotives the front end indication can be indicated on the rear end of the locomotive.

**Responsibilities**

OR.DEF.637

**Driver**

You must ensure that correct front end indication of your train or vehicle is always applied during any movements.

When passing oncoming trains or vehicles and when performing shunting movements, you must ensure that the front end indication is dimmed.

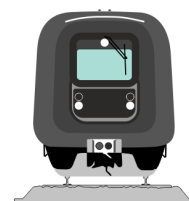

OR.DEF.873

**Driver**

If the front end indication of the train fails during a mission, such that a minimum of two white lights cannot be shown, you must inform the Signaller and ensure that the speed of the train does not exceed 40 km/h.

OR.DEF.23

**Incompatibility between train and route**

OR.DEF.24

**DEFINITION**

Incompatibility between train and route is when the traction power requirements and/or the gauge of a route cannot accommodate a train.

Electric traction units are reported via the onboard train data and out of gauge information is reported via Railway Undertaking train data.

The Signaller must detect incompatibility between train and route and prevents the route from being set.

**Responsibilities**

OR.DEF.25

**Signaller**

When a route is blocked from setting due to incompatibility between train and route you may only use the Signaller override function to override the incompatibility, or authorise the train to proceed using an Operational Instruction, when the incompatibility can be resolved with the Driver.

OR.DEF.648

**Missing rear end indication**

OR.DEF.649

DEFINITION

Missing rear end indications is a permission to allow a single train to run without rear indications when it has been identified during inspection of the train, that the train cannot run with normal rear indication.

The permission is given by the Dispatcher over a specified portion of the network following a request from the Railway Undertaking. The Dispatcher must ensure that all affected Signallers are informed.

Responsibilities

OR.DEF.650

Signaller

You must ensure that information about a train with missing rear end indications is entered into the Signaller log.

OR.DEF.651

Signaller

To authorise a train into a track section which is indicated as occupied, following a train with missing rear end indications, you must verify that the train has completely vacated the area before allowing an OS MA or Operational Instruction into the track section indicated as occupied.

OR.DEF.171

**Train awakening**

OR.DEF.172

DEFINITION

Train awakening is to prepare the train control system for start of mission by switching it on and entering necessary train data. If the train is within a level 2 area train awakening includes connecting to the data radio network.

OR.DEF.850

**P-brake**

OR.DEF.852

DEFINITION

Trains which are brake only by the P-brake, or a combination of the P-brake and G-brake, are defined as P-braked.

When the P-brake is used in combination with the G-brake, the G-brake weight is at most 10 % of the train's total brake weight.

For freight trains with a hauled weight between 1200 and 1600 tonnes (regardless of train length and weight), the traction unit(s) and the first five wagons may be set to G-brake even though this causes the total G-brake weight of the train to be more than 10 %.

Permanently coupled wagons are regarded as one wagon.

Responsibilities

OR.DEF.854

Driver

You must ensure that the total G-brake weight does not exceed 10 % of the total brake weight of the train, when the P-brake is used in combination with the G-brake.

OR.DEF.855

Driver

For freight trains with a hauled weight between 1200 and 1600 tonnes (regardless of train length and weight), you may allow the traction units and the first five wagons to be set to G-brake even though this causes the total G-brake weight of the train to be more than 10 %.



OR.DEF.856

## **R-brake**

OR.DEF.857

### DEFINITION

Trains which are braked only by the R-brake, or a combination of the R-brake and P-brake, are defined as R-braked.

When the R-brake is used in combination with the P-brake, a maximum of 1/3 of the train's braking unit are set to P-brake.

### Responsibilities

OR.DEF.859

#### **Driver**

You must ensure that no more than 1/3 of the units in the train are set to P-brake, when the R-brake is used in combination with the P-brake.

OR.DEF.115

## **Onboard self test**

OR.DEF.116

### DEFINITION

When the onboard is switched on, an onboard self test will ensure elements of the onboard, which may affect safety are tested.

The onboard self test is only possible while the train is at a standstill.

The result of the onboard self test will be displayed on the DMI.

### Responsibilities

OR.DEF.117

#### **Driver**

If the DMI displays information about a failed onboard self test, you must switch off the onboard and then switch it on again to trigger a second self test. If the second self test fails, you must not consider the train safe and fit for service.

OR.DEF.113

## Safe and fit for service

OR.DEF.114

### DEFINITION

Safe and fit for service determines if the rolling stock is qualified to be included in a train performing supervised movements.

Safe and fit for service centres around two states:

1. Safe - the rolling stock does not pose a threat to other trains and/or the infrastructure
2. Fit - the rolling stock is able to comply with the planned mission.

The minimum requirements for a train to classify as safe and fit for service are:

Safe:

- conditions for specific rolling stock use permit are met. This includes checking that the following is functioning:
  - a) onboard
  - b) front end indication
  - c) rear end indication
  - d) audible warning device (checked according to internal Railway Undertaking procedures)
- freight cargo securely loaded (if applicable)
- brakes tested and in working order
- all units in the train are connected to the continuous braking system
- the brake percentage of the train is at least 50 (exempting snow ploughs)
- the front and rear units have automatic brakes (exempting snow ploughs).

Fit:

- tunnel checks performed (if applicable)
- brake performance is compatible with the scheduled mission
- trained personnel needed for the scheduled mission is available
- train consist is compatible with the scheduled mission
- train speed compatible with the scheduled mission
- train length compatible with the scheduled mission.

In order to be safe and fit for service a train must fulfill both the requirements of ORF as well as any other requirements resulting from other sets of rules that may apply to the scheduled journey of the train.

OR.DEF.638

## Rear end indication

OR.DEF.639

### DEFINITION

The rear end indications are indicated by two steady red lights on the rear unit of the train.

These lights are horizontally aligned.

The rear end indications for trains that cannot be indicated by two steady red lights can instead be indicated by 2 reflective plates with white side triangles and red top and bottom triangles.

For propelling movements the rear end indications can be indicated on the front end of the train.

Driving with missing rear indications can be authorised by the Dispatcher.

### Responsibilities

OR.DEF.640

#### Driver

You must ensure that correct rear end indication of your train or vehicle is always applied during any movements.

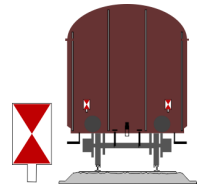
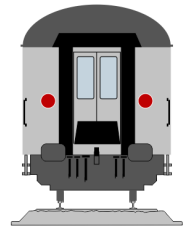

OR.DEF.173

**Onboard train data**

OR.DEF.174

**DEFINITION**

Onboard train data is information stored in the onboard to describe the characteristics of a train.

Onboard train data is:

- ETCS operational train category
- train length
- traction and deceleration data
- maximum train speed
- loading gauge
- axle load/meter weight
- power supply accepted by the train
- train fitted with airtight system
- additional data for the available STMs
- number of axles.

All supervised trains are controlled by the interaction between assigned movement authorities from the signalling system and the stored onboard train data and the safety of the system is dependant of the data being correct.

Some train data can be fixed by rolling stock specific configuration. Fixed data are not available for the Driver to edit.

Other train data is entered by the Driver and can be available as predefined values. For these data entries, the Driver only needs to acknowledge the data, or modify the data by entering or selecting the correct value.

**Responsibilities**

OR.DEF.175

**Driver**

You must ensure that the onboard train data is updated to be consistent with the train whenever the consist or performance of the train changes. If the train has a movement authority indicated in the DMI, you must close the desk and perform a new start of mission before updating the train data.

OR.DEF.865

**Train length**

OR.DEF.866

**DEFINITION**

The train length is measured in metres and is the full length of the train including working traction units.

The maximum permitted train length for R-braked trains is 400 metres.

The maximum permitted train length for P-braked trains is:

- 400 metres, when the speed is above 120 km/h
- 600 metres, when the maximum speed is 120 km/t
- 835 metres, when the maximum speed is 100 km/t.

The maximum permitted train length for G-braked trains is 835 metres.

OR.DEF.532

## **Train consist**

OR.DEF.533

### DEFINITION

The train consist is a specification of the different rolling stock forming a train.

OR.DEF.867

## **Train and hauled weight**

OR.DEF.868

### DEFINITION

Train and hauled weight is measured in tonnes.

When calculating the train weight, all units in the train are included (including working traction units).

When calculating the hauled weight, working traction units are not included.

The maximum permitted hauled weight is 2500 tonnes.

The maximum permitted train weight, for trains driving faster than 120 km/h, is 1200 tonnes.

OR.DEF.123

## **Inconsistent train running number**

OR.DEF.124

### DEFINITION

When a train running number is unknown by the signalling system, or is already in use, the signalling system will trigger a warning on the signalling control display to the Signaller. A text message is displayed to the Driver in the DMI.

### Responsibilities

OR.DEF.125

#### **Driver**

When the text message "Inconsistent train running number" is displayed on your DMI, you must check that the train running number entered is correct and update if required. If the text message Inconsistent train running number is received again, you must inform the Signaller.

OR.DEF.425

## **Invalid or unknown position**

OR.DEF.426

### DEFINITION

Invalid or unknown position is when the status of the train position held by the onboard cannot be validated by the signalling system.

When the Driver of a train with an invalid or otherwise unknown location has updated the onboard with a train running number and requests a mode change this will be indicated on the signalling control display.

OR.DEF.326

## Unusual transport

OR.DEF.327

### DEFINITION

Unusual transport (UT) is railway transports exceeding weight, dimensions, usage of wagons, loading method etc. that must only be transported according to a special permission. This permission is called a "transport permission". Restrictions applying to the transport are stated in the transport permission.

The restrictions will ensure that infrastructure is not damaged by limiting the use of specific tracks or placing restrictions on speed. Restrictions will be handled in co-operation between the Signaller and the Driver.

### Responsibilities

OR.DEF.328

#### Driver

You must ensure that all restrictions applying to your train which are stated in the UT transport permission are met.

OR.DEF.329

#### Signaller

You must ensure that route setting for trains transporting UT is in line with the restrictions stated in the UT transport permission.

OR.DEF.688

## Shunting

OR.DEF.465

### Safe for shunting movement

OR.DEF.466

### DEFINITION

Safe for shunting movement means that the traction unit and/or wagons are in a safe condition to perform an unsupervised movement.

Preparation of the traction units testing that the following works:

- brakes
- radio- or mobile telephone connection between the Driver and Shunter
- audible warning device (checked according to internal Railway Undertaking procedures).

Preparation of wagons means that the movement can be performed without causing damage to infrastructure or rolling stock.

OR.DEF.160

**Temporary shunting area**

OR.DEF.161

**DEFINITION**

A temporary shunting area is an interlocked area temporarily set up to allow shunting operations. A temporary shunting area is always under the responsibility of a Shunting area manager.

A temporary shunting area is established to ensure that all track leading out of the area is limited by facing ETCS stop markers, unless points can be blocked to prevent movement out of the area.

A temporary shunting area can be limited by a buffer stop not fitted with an ETCS stop marker or by a permanent shunting area.

The time period allowed for the temporary shunting area is agreed between the Signaller and Shunting area manager before the temporary shunting area is established.

In locations, where shunting in temporary shunting areas often occurs, the most commonly used areas may be defined in the location specific descriptions by a name or number.

Points in the temporary shunting area are released for the Shunting area manager to control via the handheld terminal, if not locked for safety reasons. If the handheld terminal is not available, the Shunting area manager requests the Signaller to throw the points inside the area.

**Responsibilities**

OR.DEF.164

**Signaller**

You must agree the boundaries and timing of the temporary shunting area with the Shunting area manager.

All movements in and out of the temporary shunting area must be coordinated between you and the Shunting area manager.

OR.DEF.166

**Shunting area manager**

You must agree the boundaries and timing of the temporary shunting area with the Signaller. When the temporary shunting area is established you are in charge of that particular area of infrastructure.

All movements in and out of the temporary shunting area must be coordinated between you and the Signaller.

OR.DEF.167

**Shunting area manager**

You must regulate shunting movements within the temporary shunting area to be conducted safely.

OR.DEF.87

**Permanent shunting area**

OR.DEF.88

**DEFINITION**

A permanent shunting area is a non-interlocked area which is bounded by an ETCS stop marker at the exit. No ETCS stop markers are located within a permanent shunting area.

At the exit from the permanent shunting area, there are balises placed to ensure update of a valid position. A further balise may be installed which will protect against an active desk exiting the permanent shunting area without authority unless a movable element at the exit already provides this protection.

Location specific descriptions may contain special provisions and regulations applying to the movement of trains and vehicles in a permanent shunting area. When a permanent shunting area has a Shunting area manager assigned, information about this can be found in the location specific description.

Movements performed inside a permanent shunting area are the responsibility of the Shunter. Several movements can take place in the area at the same time.

An area behind a handheld terminal operated point is a permanent shunting area, but this area are not normally equipped with ETCS stop markers at the exit of the area.

**Responsibilities**

OR.DEF.89

**Signaller**

For areas where there is a local Shunting area manager present, you must coordinate all movements in and out of the permanent shunting area with the Shunting area manager.

OR.DEF.90

**Shunting area manager**

All movements in and out of the permanent shunting area must be coordinated between you and the Signaller.

You must regulate shunting movements within the permanent shunting area to be conducted safely.

OR.DEF.847

**Shunter**

In permanent shunting areas you must be aware of other movements.

In permanent shunting areas where no Shunting area manager is available, you must coordinate movements out of the permanent shunting area with the Signaller.



OR.DEF.126

**Shunting movement**

OR.DEF.127

DEFINITION

A shunting movement is a movement on a route for shunting or within a possession, a permanent or a temporary shunting area.

Passenger trains do not perform shunting movements.

All shunting movements are controlled by a Shunter.

The maximum permitted speed for shunting movements is 25 km/h.

Warning systems at passenger and staff crossings are not necessarily activated for shunting movements.

Responsibilities

OR.DEF.128

**Driver**

When you are driving on a route for shunting, or inside a possession, permanent or temporary shunting area you must only carry out movements agreed with the Shunter.

OR.DEF.129

**Shunting area manager**

You are responsible for the safe regulation of all shunting movements inside your area of control and for the communication with all other participants.

OR.DEF.554

**Shunting area**

OR.DEF.555

DEFINITION

A shunting area is a collective term used for permanent and temporary shunting areas.

OR.DEF.560

**Shunting area manager ID**

OR.DEF.561

DEFINITION

A Shunting area manager ID is a unique identifier for every Shunting area manager when using a handheld terminal. The ID is used to identify the responsible Shunting area manager to the signalling system.

The ID is assigned by Banedanmark.

OR.DEF.503

**Route for shunting**

OR.DEF.504

DEFINITION

A route for shunting is a route locked for a specific shunting movement.

Routes for shunting are normally automatically released as the train travels through the route. Routes for shunting can also be manually released by the Signaller when it has been ensured that the train is at standstill.

Responsibilities

OR.DEF.887

**Signaller**

You must ensure that the train is at standstill before you manually release a route for shunting.

OR.DEF.869

## Shunting path

OR.DEF.870

### DEFINITION

A shunting path is the sections of track from the front end of the shunting consist to the agreed end location for the shunting movement.

OR.DEF.689

## Signalling System

OR.DEF.355

### Signalling control display

OR.DEF.356

### DEFINITION

The signalling control display indicates the current status of the objects controlled by the signalling system to the Signaller. It provides an interface that the Signaller can use to operate the signalling system e.g. set routes, throw points and update train running numbers.

The validity status of the information presented on the signalling control display can be evaluated by a special indicator.

### Responsibilities

OR.DEF.357

#### Signaller

You must not rely on the information displayed on the signalling control display if you have reason to believe that the information is incorrect, or if the status of the special indicator shows that the information is not up to date.

OR.DEF.581

## Moveable elements

OR.DEF.582

### DEFINITION

Moveable elements are the elements of the track that can serve more than one purpose by changing between different states.

A moveable element that is interlocked has to be reported in the correct and locked state to allow supervised movements.

Moveable elements are:

- points
- derailleurs
- bascule bridges.

OR.DEF.446

## **Brake intervention**

OR.DEF.447

### DEFINITION

A brake intervention is an automatic application of the brakes commanded by the onboard. The brake intervention can be caused by over speeding, failing to acknowledge a mode change or by failing to acknowledge a level transition.

The onboard will supervise the train speed within pre-defined tolerances according to the actual speed of the train.

Depending on how high the overspeed is, the Driver may experience either an audible warning or a brake intervention.

When the Driver fails to acknowledge a mode change or level transition, the onboard will automatically perform a brake intervention.

When the TR-mode or SF-mode is entered the brakes will automatically be applied.

The brake intervention is released when the speed goes below the permitted speed or the Driver acknowledges the mode change or level transition causing the brake intervention.

OR.DEF.14

**End of authority**

OR.DEF.15

**DEFINITION**

The end of authority (EOA) is the location to which a train running on a movement authority will be supervised to a standstill, or the location to which a train running on an Operational Instruction is authorised to proceed.

The end of authority is indicated to the Driver on the DMI. The end of authority is only indicated on Operational Instructions when it is not the next ETCS stop marker.

For supervised trains, the signalling system will supervise the train to a standstill at the end of authority. If the Driver fails to react to an intervention warning the onboard will automatically command a brake intervention. When a movement authority is extended the end of authority is updated according to the new information.

For unsupervised trains, the Driver is responsible to bring the train to a standstill at the end of authority indicated on of the Operational Instruction form unless a movement authority is displayed on the DMI which allows the continued driving passed the end of authority.

**Responsibilities**

OR.DEF.16

**Driver**

You must control the train to a standstill at the end of authority.

You must never pass the end of authority, unless instructed to do so by the Signaller on Operational Instruction 1 or Operational Instruction 7.

When approaching the end of authority at an ETCS stop marker, you must control your train to a standstill at a distance from where the identity of the ETCS stop marker can be clearly read.

OR.DEF.17

**Driver**

When approaching the end of authority at a buffer stop you must control your train to a standstill at a safe distance to the ETCS stop marker fitted on the buffer stop.

OR.DEF.21

**FS MA**

OR.DEF.22

**DEFINITION**

An FS MA is a fully supervised movement authority performed in FS-mode.

The FS MA provides full route protection and track covered by the MA unoccupied.

The FS MA is used for normal running.

OR.DEF.404

**Ceiling speed supervision**

OR.DEF.405

DEFINITION

Ceiling speed supervision is the control of the maximum speed permitted by the onboard. The ceiling speed is determined by the onboard using the most restrictive speed provided by the signalling system, the driving mode, the onboard national values or the maximum permitted speed of the rolling stock. The driver will receive a warning if the ceiling speed is exceeded and above a limiting value a brake application will occur.

The ceiling speed is indicated to the Driver on the DMI.

OR.DEF.388

**Detected point**

OR.DEF.389

DEFINITION

A point is detected when the signalling control display indicates a lie of the point.

OR.DEF.517

**Movement authority**

OR.DEF.518

DEFINITION

A movement authority (MA) is the permission from the signalling system that defines the conditions under which the train is authorised to move forward on the track ahead.

Movement authorities are controlled by the signalling system.

Responsibilities

OR.DEF.519

**Driver**

If no movement authority is obtained when expected, you must inform the Signaller.

OR.DEF.364

**Standstill report**

OR.DEF.365

DEFINITION

A standstill report is an automatically generated message from the onboard to the signalling system whenever a train with active communication session reaches a standstill. The train has not necessarily reached the end of authority, or is intending to remain at a standstill.

OR.DEF.120

**Emergency shortening of movement authority**

OR.DEF.121

DEFINITION

An emergency shortening of a movement authority is when the movement authority is automatically shortened by the signalling system for safety purposes or by a deliberate action from the Signaller.

An emergency shortening of a movement authority may cause a brake application and it may result in a change to TR-mode.

Responsibilities

OR.DEF.122

**Signaller**

You must only use an emergency shortening of a movement authority in case of an emergency.

OR.DEF.259

**Driver**

If the text "Emergency stop" is displayed on the DMI you must assume that there is a dangerous situation and you must perform all actions necessary to avoid or reduce the effect of this situation.

OR.DEF.9

**Emergency stop**

OR.DEF.10

DEFINITION

An emergency stop is an order the Signaller can use to stop one specific train, trains within an area defined by the Signaller or all trains in the area of control of the Signaller. The emergency stop order is only used in case of an emergency.

The emergency stop will cause affected train(s) to enter TR-mode immediately. For as long as the emergency stop is activated the train(s) cannot receive new movement authorities.

Responsibilities

OR.DEF.11

**Driver**

When the text "Emergency stop" is displayed on the DMI you must assume that there is a dangerous situation and you must perform all actions necessary to avoid or reduce the effect of this situation.

OR.DEF.12

**Signaller**

When an emergency situation occurs you may use the emergency stop order to bring trains to a standstill if this can in any way help to avoid or reduce the effect of this situation.

OR.DEF.118

**Operational shortening of movement authority**

OR.DEF.119

DEFINITION

An operational shortening of a movement authority is when the Signaller requests that a movement authority held by a train, is shortened for operational purposes. The onboard will reject the shortening request if it could cause a brake application immediately or within a few seconds.

The Driver may notice that the distance covered by the movement authority is shortened, and a speed reduction may be necessary soon after.

OR.DEF.76

**OS MA**

OR.DEF.77

DEFINITION

An OS MA is a restricted movement authority performed in OS-mode and under the conditions of on sight.

An OS MA offers only limited route protection, and the track could be occupied by another train, vehicle or other obstacle.

The OS MA is used for joining, section sharing, after start of mission and for authorising a train into an area where the signalling system cannot determine if the track section is occupied. For planned joining, section sharing and start of mission, the Signaller is not required to acknowledge the issuing of an OS MA.

Responsibilities

OR.DEF.846

**Signaller**

You must ensure that the track section is, or is presumed to be, unoccupied before you acknowledge the issuing of an OS MA, unless you wish to authorise the train to enter an occupied track section.

OR.DEF.434

**Production plan**

OR.DEF.435

DEFINITION

The production plan is an online tool which contains the information enabling the signalling system to decide the sequence and paths of trains for routes to be called automatically in order to facilitate automatic route setting. The timetable of individual trains can be seen in the production plan.

All changes to the production plan are communicated and coordinated through the production plan.

Responsibilities

OR.DEF.901

**Signaller**

In the event of traffic irregularities, you must ensure that the dispatcher is informed immediately.

OR.DEF.436

**Dispatcher**

You must ensure that the production plan is always up to date.

OR.DEF.347

**Route**

OR.DEF.348

DEFINITION

A route is a path secured for one train through the track infrastructure that allows a safe movement.

A route is set and locked by the signalling system before it can be used and automatically released after use, or by manual release requested by the Signaller.

OR.DEF.351

## Route setting

OR.DEF.352

### DEFINITION

The signalling system requests route setting automatically according to the production plan, but it can be performed manually by the Signaller.

Manually routing a train with a train running number known by the signalling system will automatically update the production plan with the set route.

Manual route setting is supervised by the signalling system to avoid unintentional Signaller override of routing restriction.

OR.DEF.526

## Signalling system

OR.DEF.527

### DEFINITION

The signalling system is a collective term used when referring to the equipment not on board the train used to control the safe and efficient operation of train movements.

OR.DEF.440

## Route protection

OR.DEF.441

### DEFINITION

Route protection consists of the technical conditions ensuring that the route can be travelled safely by the train. The requirements for technical protection are not the same for an FS MA as for an OS MA or route for shunting. The technical conditions required for an FS MA are:

- all points in the route (including the overlap) are in the correct lie and locked against throwing
- points required for flank protection are in the correct lie and locked against throwing
- track sections in the route, and specific adjacent track sections, are unoccupied.

The technical conditions required for an OS MA and a route for shunting are all points in the route are in the correct lie and locked against throwing.



OR.DEF.110

**Runaway movement protection**

OR.DEF.111

DEFINITION

Runaway movement protection is a set of onboard train functions used to apply the brakes if a train moves unintentionally:

- roll away protection against movements opposite to the direction of the direction controller and either direction when the direction controller is in a neutral position.
- backwards movement protection against movements in the opposite direction of a valid MA.
- standstill supervision against movement in either direction when in SB-mode.

The brakes will be applied if the train travels more than 2m.

Responsibilities

OR.DEF.112

**Driver**

When the text message "Runaway movement" is displayed on your DMI you must immediately secure the train from any further unintentional movements.

OR.DEF.631

**Point machine**

OR.DEF.632

DEFINITION

A point machine is used to electrically throw a point from one position to the other.

OR.DEF.591

**Interlocked area**

OR.DEF.592

DEFINITION

An interlocked area is infrastructure under the control and supervision of the signalling system.

OR.DEF.437

**Protection requirements**

OR.DEF.438

DEFINITION

Protection requirements for a possession or temporary shunting area are technical precautions set up by the signalling system to prevent unintentional route setting into the area, or unintentional movements out of the area. Route setting is prevented by disabling automatic route setting, blocking all signalling within the area and blocking moveable elements in connection to the area.

Protection requirements are defined during the planning phase.

Responsibilities

OR.DEF.439

**Signaller**

You must ensure that protection requirements are defined during the planning of impromptu possessions or temporary shunting areas.

OR.DEF.520

## Occupancy detection

OR.DEF.521

### DEFINITION

Occupancy detection is performed by use of axle counters to establish if rolling stock is present in an axle counter section.

The status of axle counter sections in interlocked areas are continually supervised by the signalling system and occupancy status indicated on the signalling control display.

OR.DEF.522

## Signaller override

OR.DEF.523

### DEFINITION

Signaller override is when system imposed restrictions or functionality is deliberately disabled by the Signaller.

Signaller override requires an acknowledgement from the Signaller.

### Responsibilities

OR.DEF.525

#### Signaller

You must only use the Signaller override function when it has been verified that it is safe to do so.

OR.DEF.422

## Signaller log

OR.DEF.423

### DEFINITION

The Signaller log is a record of safety related messages for the area being controlled by a Signaller from the Traffic Control Centre. The Signaller log can contain information automatically generated and manually entered information.

This includes:

- point management
- possession management
- infrastructure restrictions
- catenary isolations
- Signaller responsible for area
- any other information of importance to safety.

### Responsibilities

OR.DEF.424

#### Signaller

You must ensure that the Signaller log is updated with all safety related information concerning your area of responsibility.

OR.DEF.698

## Possession

OR.DEF.284

## Corrective maintenance

OR.DEF.285

### DEFINITION

Corrective maintenance is a process of repairing a system or component of the railway infrastructure system.

Corrective maintenance can only be performed by maintainers, and can be performed with or without a possession. Authorisation from the O&M coordinator is required in each instance.

Corrective maintenance requiring a possession, or in other ways affecting the safety of the operational railway, is an impromptu agreement between the Signaller and the authorised maintainer.

Corrective maintenance taking place in a possession is coordinated between the PICOP and the authorised maintainer.

### Responsibilities

OR.DEF.286

### PICOP

Before you request a possession for corrective maintenance you must assess safety at the location to be under possession.

OR.DEF.340

## Impromptu Possession

OR.DEF.341

### DEFINITION

An impromptu possession is a possession planned in a special way. It is a last minute possession with the railway safety plan being prepared on-site. An impromptu possession can only be used for corrective maintenance and only if the maintainer is called for by the O&M coordinator.

Planning information is communicated directly to the Signaller.

OR.DEF.303

## Handheld terminal

OR.DEF.304

### DEFINITION

A handheld terminal is a portable device used to assist trackside operations. The device communicates with the signalling system and enables an authorised user to manage:

- possessions
- temporary shunting areas
- shunting movements
- points control.

The user logs on to the handheld terminal to access functions specific to their role.

OR.DEF.624

## Railway safety plan

OR.DEF.625

### DEFINITION

The railway safety plan describes the railway related safety specific issues concerning the work on or near an operational track.

Before commencing any planned work on or near an operational line an approved railway safety plan is produced.

Before commencing any planned work at the platforms where public access is allowed an approved railway safety plan is produced.

Before commencing any planned work outside the personal safety distance but closer than 4 meters to the nearest rail a railway safety plan is produced.

The railway safety plan describes the specific safety arrangements necessary to mitigate any hazard regarding the work in question.

The railway safety plan is to be approved by the TWSC.

For complicated infrastructure works involving several worksites an overarching coordinating railway safety plan can be required.

### Responsibilities

OR.DEF.626

Contractor

You must ensure that an approved railway safety plan is available for all work on or near an operational track.

OR.DEF.612

## ID card

OR.DEF.613

### DEFINITION

The ID card is issued to all personnel that have a proven railway competence, except Drivers. The ID card indicates which railway competencies the holder possesses.

The ID card is personal and holds the name, ID number, photograph of the person to whom it is issued to, company name and an expiration date.

### Responsibilities

OR.DEF.614

All

You must carry your ID card with you at all times while performing railway related tasks.

OR.DEF.396

**Worksite protection**

OR.DEF.397

**DEFINITION**

Worksite protection is placing dual faced stop markers in between the rails to indicate to track workers the boundary of the worksite inside a possession. The Rules for working in infrastructure describe the requirements for the placing of dual faced stop markers.

Worksite protection is used to protect staff and infrastructure against all train movements into the worksite, and prevent all movements from leaving the worksite without authorisation.

Worksite protection is the last barrier of protection when working inside a possession.

**Responsibilities**

OR.DEF.643

**PICOP**

Before permitting work to commence, you must ensure that dual faced stop markers are placed within the possession in the middle of all tracks leading into the worksite.

OR.DEF.644

**PICOP**

You may authorise the dual faced stop marker to be removed for the purpose of moving trains or vehicles across the worksite boundary.

You must ensure that the dual faced stop marker is replaced immediately after the train or vehicle has passed the worksite boundary.

OR.DEF.610

**Area with public access**

OR.DEF.611

**DEFINITION**

An area with public access is a part of the railway system where the public is permitted to reside or transverse without possessing any railway competencies, e.g. a platform or passenger crossing.

OR.DEF.620

**Track crossing**

OR.DEF.621

**DEFINITION**

A track crossing is an arrangement used to transport materials or machinery over the tracks to get to and from a worksite.

**Responsibilities**

OR.DEF.622

**PICOSS**

Before transporting materials or machinery across a temporary track crossing you must contact the Signaller for approval in every single case, unless other instructions have been given by the Person responsible for traffic operation.

OR.DEF.623

**Signaller**

Before authorising the passage of a track crossing with materials or machinery you must ensure that no train or vehicle will approach the track crossing until the PICOSS has reported that the track is cleared.

OR.DEF.338

## **Planned Possession**

OR.DEF.339

### DEFINITION

A planned possession is prepared by the planning department to fit the production plan or the production plan is adjusted to contain the possession. A planned possession is announced in a possession report with a unique identifier.

The railway safety plan is always prepared in connection with the possession planning.

Planned possessions are viewable in the signalling system.

OR.DEF.617

## **Personal safety distance**

OR.DEF.618

### DEFINITION

The personal safety distance is the closest distance to an operational railway that it is safe for persons to approach outside areas with public access. The personal safety distance to operational tracks measured from the nearest rail are:

- 1.75 m for speeds of 120 km/h or below
- 2.25 m for speeds above 120 km/h.

### Responsibilities

OR.DEF.619

All

When walking on or near an operational railway you must stay outside the personal safety distance when trains or vehicles are passing.

OR.DEF.333

**Possession**

OR.DEF.334

DEFINITION

A possession is when a section of track is taken out of normal operation for e.g. fault correction or maintenance. The section of track under possession is under the authority of a PICOP, and all movements within the possession are controlled by the PICOP as shunting with the PICOP acting as Shunting area manager.

A possession is established to ensure that all track leading out of the possession is limited by facing ETCS stop markers, unless points can be blocked to prevent movement out of the possession.

A possession can be limited by a buffer stop not fitted with an ETCS stop marker or by a permanent shunting area.

Possessions in transition areas are established between the system border and an ETCS stop marker.

A possession may contain one or more worksites.

All possessions are as far as possible ended at the agreed time. In case a possession cannot be ended at the agreed time, the PICOP informs the Signaller.

Points in the possession are released for the PICOP to control via the handheld terminal, unless they are prevented from throwing for safety reasons. If the handheld terminal is not available, the PICOP requests the Signaller to throw the points inside the possession.

Responsibilities

OR.DEF.335

**Signaller**

You must coordinate all movements going in to or out of the possession with the PICOP.

OR.DEF.336

**PICOP**

You are responsible for the safe regulation of all shunting movements, for communication with other participants and for the safety of work taking place in your area of control.

OR.DEF.337

**PICOP**

You must coordinate all movements going in to or out of the possession with the Signaller.

OR.DEF.661

**PICOP**

In case your possession cannot be ended at the agreed time, you must inform the Signaller about the expected delay as soon possible.

OR.DEF.487

**Possession ID number**

OR.DEF.488

DEFINITION

A possession ID number is a unique number identifying individual possessions. It is used to identify the individual possession to the signalling system, the Signaller and the PICOP when establishing, ending and handing over of possessions.

The possession ID number is assigned during the planning process when possession information is updated into the signalling system.

OR.DEF.574

**PICOP ID**

OR.DEF.575

DEFINITION

The PICOP ID is used to identify the PICOP and is assigned by Banedanmark once the PICOP has obtained competence to act as a PICOP.

OR.DEF.615

**Position of safety**

OR.DEF.616

DEFINITION

The term position of safety is used in relation to vacating the track when a train or a vehicle is approaching.

Position of safety is a position outside the personal safety distance to an operational railway or a defined position within a possession stipulated by the railway safety plan.

OR.DEF.690

**Terms**

OR.DEF.417

**Book of Forms**

OR.DEF.418

DEFINITION

All Operational Instruction forms and other forms referenced in ORF are collected in a Book of Forms contained in Appendix A of ORF.

All the forms contained in the Book of Forms can be identified by an Operational Instruction number or a name.

OR.DEF.102

**Data radio hole**

OR.DEF.103

DEFINITION

Data radio hole refers to an area where there is an insufficient level of radio coverage to achieve the minimum data rate necessary for communication between onboard and signalling system.

OR.DEF.558

**ETCS**

OR.DEF.559

DEFINITION

ETCS is the abbreviation for European Train Control System and is the system used on the Fjernbane to protect trains against overspeed and overrunning of the end of authority.

OR.DEF.491

**Staff**

OR.DEF.492

DEFINITION

Staff is the term used for people who are certified to assume the responsibility of the duties within their area of competence.



OR.DEF.493

## Rolling stock

OR.DEF.494

### DEFINITION

Rolling stock is the collective name for the wheeled railway equipment that moves on the rails and meets the minimum requirements for railway operation.

Rolling stock is considered electrical when the pantograph is raised and in contact with the overhead wire.

OR.DEF.888

## Legacy signaller

OR.DEF.889

### DEFINITION

Legacy signaller is the term used for the role in level 0 or level ATC which corresponds to Signaller in ORF.

OR.DEF.349

## Route Book

OR.DEF.350

### DEFINITION

A description of the railway lines and the associated trackside equipment for the operated lines which have relevance to the driving task.

OR.DEF.583

## Authority to move

OR.DEF.584

### DEFINITION

An authority to move is a collective term used for the permission given to a Driver to move a train or vehicle.

An authority to move can be given by:

- movement authority on the DMI
- Operational Instruction 1, Operational Instruction 2, Operational Instruction 7 or Operational Instruction 21 from the Signaller to the Driver
- shunting instructions from the Shunter to the Driver.

### Responsibilities

OR.DEF.585

#### Driver

You may only begin procedures to move your train or vehicle when an authority to move has been received.

OR.DEF.495

## Traffic control centre

OR.DEF.496

### DEFINITION

Traffic control centre is the location from which railway traffic is supervised and controlled.

Telephone numbers for the traffic control centre can be found in the Route Book.

OR.DEF.645

**Signaller protected area**

OR.DEF.646

DEFINITION

A Signaller protected area is an area of the infrastructure for which the Signaller uses available signalling controls to provide safe conditions for unplanned short-term access to the tracks or violation of the safety distance for machinery. The Signaller protected area is applied in a situation where this is immediately necessary outside of a possession. Signaller protected areas can be used in situations requiring e.g. Emergency services access to tracks, for Drivers to clamp points, for Drivers to inspect trains or if the safety distance for machinery is violated. In a Signaller protected area it is not allowed to perform maintenance or infrastructure work. Banedanmark response services may be put on track and drive in a Signaller protected area.

OR.DEF.589

**Traction unit**

OR.DEF.590

DEFINITION

Traction unit is the collective term used for self-propelled rolling stock and covers locomotives, train sets, rail tractors and rail mounted machinery.

Traction units are considered electrical when the pantograph is raised and in contact with the overhead wire.

OR.DEF.691

**Train Radio**

OR.DEF.182

**No network**

OR.DEF.183

DEFINITION

No network indicates that the train radio has lost communication to the train radio network.

Responsibilities

OR.DEF.184

**Driver**

When the text message "No network" is displayed on the train radio you must inform the Signaller, using any means available.

OR.DEF.4

**Railway emergency call**

OR.DEF.5

DEFINITION

A railway emergency call is a high priority call that supersedes normal train radio calls. When the red railway emergency call button is pressed on the train radio, it automatically connects the Driver and the controlling Signaller. All other train radio users in the group will be included in the call to listen in.

Responsibilities

OR.DEF.6

**Driver**

You must use the railway emergency call if observing or involved in an emergency situation.

To initiate an emergency call, you must use the red railway emergency call button on the train radio handset.

OR.DEF.7

**Driver**

When you hear that a railway emergency call is in progress, you must immediately reduce the speed of the train to maximum 40 km/h and proceed driving on sight until the Signaller informs you that it is no longer required to do so.

You must bring the train to a standstill if the emergency situation affects your journey, or if you do not understand the content of the railway emergency call. You may continue driving when authorised by the Signaller.

OR.DEF.8

**Signaller**

When you receive a railway emergency call, you must postpone non-emergency tasks and immediately handle the emergency call.

OR.DEF.562

**Radio ID**

OR.DEF.563

DEFINITION

The radio ID is the number entered into the radio to enable individual identification of all radio users.

For trains, the radio ID is always the train running number if available. If a train running number is not available the fixed rolling stock ID number is used as radio ID.

For portable radio units the radio ID is always the personal ID of the user.

OR.DEF.179

## Train Radio

OR.DEF.180

### DEFINITION

The train radio is the primary tool for voice communication between the Driver and the Signaller, or between the Driver and the Shunter.

The Driver can select between two states in the train radio, either "Train" or "Shunting".

A number is entered into the radio, or automatically transmitted from the onboard, to identify the train radio to the radio system. For movements according to and in connection to the timetable the number will be the train running number, for other movements it will be a fixed number assigned to the traction unit or the train running number with "99" in front.

Information on the radio network is available in the Route Book.

### Responsibilities

OR.DEF.181

#### Driver

You must ensure the train radio is updated to the correct network following the crossing of a country border. If you are engaged in an emergency call you must postpone updating the network until the emergency call is concluded.

You must ensure that the number entered, or automatically transmitted from the onboard, in the radio is consistent with the timetable. If you are not running a scheduled movement you must enter the fixed number assigned to the traction unit.

If it is not possible to update the radio with the correct number you must inform the Signaller, using any means available.



OR.DEF.692

## Tunnels

OR.DEF.538

### Tunnel distance

OR.DEF.539

### DEFINITION

Tunnel distance is a restriction applied by the signalling system or the Signaller to ensure correct separation of trains in the tunnel when required. The tunnel separation requirements are described in the location specific descriptions.

OR.DEF.542

### Tunnel approach location

OR.DEF.543

### DEFINITION

The tunnel approach location is the last location in the infrastructure from where a train can be routed into e.g. an inspection track instead of into the tunnel.

The tunnel approach location can be found in the relevant location specific description.

OR.DEF.540

## **Tunnel restrictions**

OR.DEF.541

### DEFINITION

Tunnel restrictions are safety precautions applied at specific tunnels to reduce the risk of a hazardous situation developing in a tunnel. Tunnel restriction is e.g. tunnel distance, or restricting the use of the neighbouring tunnel while a train transporting explosives runs through the tunnel.

Tunnel restrictions can be found in the relevant location specific descriptions.

## Procedures

---

1947			<b>Normal operation</b>
1948			<b>Announcement of extra train</b>
1949	Precondition		The need for an extra train has been identified.
1950	Purpose		To inform the Signaller and Driver about the timetable change.
			<b><u>PROCEDURE</u></b>
1952	Railway Undertaking		The Railway Undertaking must have procedures to ensure that Drivers are always informed of timetable changes.
1954	Driver		If the Driver is unable to obtain the updated timetable from the Railway Undertaking the Driver must inform the Signaller.
3543	Signaller		If the Signaller is informed by a Driver that an updated timetable cannot be obtained from the Railway Undertaking, the Signaller must manually transfer the relevant parts of the timetable to the Driver.

## Normal operation



1957			
			<b>Safe and fit for service</b>
1958	Precondition		A valid timetable is available for the train.
1959	Purpose		The train is prepared for service.
			<b><u>PROCEDURE</u></b>
1960	Railway Undertaking		The Railway Undertaking must provide procedures to ensure trains are <a href="#">safe and fit for service</a> .
3740	Driver		The Driver must ensure that the train has been correctly prepared for operation. This includes ensuring that all units in the train consist are set to the correct <a href="#">brake class</a> and that all requirements for the <a href="#">train length</a> , train weight and hauled weight are fulfilled.
1961	Driver		The Driver must ensure that the <a href="#">onboard self test</a> is always performed and the result indicated on the DMI prior to starting the enter data procedure. Without a successful self test the <a href="#">onboard</a> cannot be considered <a href="#">safe and fit for service</a> .
1962	Driver		The Driver must confirm that the train is <a href="#">safe and fit for service</a> prior to performing any movement with the train.
1963	Driver		If the train cannot be made <a href="#">safe and fit for service</a> , but must be moved, the Driver must apply the procedure <a href="#">Train failure - Moving defective rolling stock</a> .

## Normal operation

1967			
			<b>Enter onboard train data</b>
1968	Precondition		The Driver is ready to bring the train into service and is ready to enter onboard train data.
1969	Purpose		To ensure the configurable data used to perform safety critical protection functions is consistent with the Train.
			<b><u>PROCEDURE</u></b>
1970	Driver		The Driver must enter <a href="#">Driver ID</a> and select the level that corresponds to the infrastructure where the <a href="#">train</a> performs the start of mission.  The Driver must then select "Train data" on the DMI.
1971	Railway Undertaking		The Railway Undertaking must have a procedure that ensures that valid <a href="#">onboard train data</a> are made available to the Driver.
1972	Driver		The Driver must ensure that updated <a href="#">onboard train data</a> is available in the <a href="#">onboard</a> or enter updated onboard train data. The Driver must verify that the <a href="#">train</a> data held by the onboard is correct.



## Normal operation

2000			<h3>Railway Undertaking train data</h3>
2001	Precondition		Train data entry completed, the train is ready to initiate mission and the signalling system checks for Railway Undertaking train data.
2002	Purpose		Ensuring that mandatory Railway Undertaking train data is available before permitting the train to begin its mission.
			<h3><u>PROCEDURE</u></h3>
2003	Railway Undertaking		<p>The Railway Undertaking must have procedures to provide up-to-date <a href="#">Railway Undertaking train data</a> to Banedanmark before any <a href="#">train</a> is authorised to begin its mission.</p> <p>The Railway Undertaking must ensure that all changes to mandatory Railway Undertaking train data are updated and acknowledged as received by Banedanmark prior to a train departing the location of the consist change.</p>
2008	Signaller		The Signaller must ensure that the mandatory <a href="#">train</a> data is available in the <a href="#">signalling system</a> before requesting a <a href="#">route</a> for a train. The Signaller may contact the Railway Undertaking to obtain the mandatory train data.
2009	Driver		<p>The Driver must ensure that all mandatory <a href="#">Railway Undertaking train data</a> has been provided by the Railway Undertaking, and that the data has been sent and received by the signaling system, before requesting a movement authority.</p> <p>The Driver must ensure that the Railway Undertaking train data is up-to-date during the entire mission of the <a href="#">train</a>.</p>
2010	Railway Undertaking		The Railway Undertaking must ensure that the Driver is informed when changes to mandatory <a href="#">Railway Undertaking train data</a> are updated and acknowledged as received by Banedanmark prior to a <a href="#">train</a> departing.

## Normal operation

2014			<b>Awakening with invalid or unknown position</b>
2015	Precondition		The Driver has pressed the Start button. The position stored by the onboard cannot be validated by the signalling system.
2016	Purpose		To authorise the Driver to begin a mission using SR-mode on an Operational Instruction 7.
			<b><u>PROCEDURE</u></b>
2017	Driver, Signaller		<p>When the position stored by the <a href="#">onboard</a> cannot be validated by the <a href="#">signalling system</a> it is not possible to issue an <a href="#">FS MA</a> or <a href="#">OS MA</a> to the <a href="#">train</a>. A press of the <a href="#">start button</a> will cause the signalling system to automatically offer the Driver to acknowledge a change to <a href="#">SR-mode</a>.</p> <p>The Signaller is informed via the <a href="#">signalling control display</a> about train's whose position cannot be validated by the signalling system.</p> <p>The position status of the train is checked when the train passes over a balise and receives a position update from the signalling system.</p>
3710	Driver		If the symbol "Acknowledge <a href="#">SR-mode</a> " is indicated on the <a href="#">DMI</a> after pressing the <a href="#">start button</a> , the Driver must inform the Signaller.
2018	Signaller		When the Driver informs that a <a href="#">movement authority</a> was not provided to the <a href="#">train</a> after pressing the <a href="#">start button</a> , the Signaller must in co-operation the Driver establish the location of the train.
2021	Signaller		<p>When the correct location of the <a href="#">train</a> has been established the Signaller must ensure that:</p> <ol style="list-style-type: none"> <li>1. Allocate the correct <a href="#">train running number</a> to the indication of the train on the <a href="#">signalling control display</a></li> <li>2. Moveable elements where authority to move on <a href="#">Operational Instruction 7</a> will be valid are detected in the correct lie and prevented from further throwing or any moveable elements where authority to move on Operational Instruction 7 will be valid are safe to pass according to the procedure Infrastructure fault -Handling of an undetected point that is not trailed, <a href="#">Infrastructure fault - Handling of a trailed point</a> or location specific description</li> <li>3. The <a href="#">track section</a> where authority to move on Operational Instruction 7 will be valid is unoccupied, unless the Signaller requires the train to enter an occupied track section, a <a href="#">possession</a> or a <a href="#">shunting area</a></li> <li>4. No other trains have authority to move within or into the track section where authority to move on Operational Instruction 7 will be valid</li> <li>5. No other trains have authority to move within or into the track section which follows the track section where authority to move on Operational Instruction 7 will be valid, unless the Operational Instruction 7 will apply to an occupied track section, a buffer stop, a possession or a shunting area</li> <li>6. Instruct the Driver to complete an Operational Instruction 7.</li> </ol>

3902	Signaller	<p>The Signaller must assess if any of the following restrictions apply to the continued driving of the <a href="#">train</a> on <a href="#">Operational Instruction 7</a>:</p> <ul style="list-style-type: none"> <li>- unusual transport restrictions,</li> <li>- electrical rolling stock,</li> <li>- restrictions specified in location specific descriptions.</li> </ul>
3903	Signaller	<p>If a level crossing is located between the <a href="#">train</a> and the <a href="#">end of authority</a> of the <a href="#">Operational Instruction 7</a>, the Signaller must apply the procedure <a href="#">Degraded operation - Passing a level crossing without a movement authority</a>.</p>
3904	Signaller	<p>If the Signaller requires the <a href="#">train</a> to enter an occupied track and it is not according to the production plan, the Signaller must inform the Driver (if relevant) of the occupying train that another train is to approach.</p>
3905	Signaller	<p>If the Signaller wants to authorise the <a href="#">train</a> into a <a href="#">possession</a> or <a href="#">shunting area</a>, the Signaller must first contact the PICOP or Shunting area manager (if relevant) and request permission for the movement.</p>
3906	Signaller	<p>When the continued driving of the <a href="#">train</a> is protected, the Signaller must instruct the Driver to complete an <a href="#">Operational Instruction 7</a>. The <a href="#">Operational Instruction 7</a> must include (as required):</p> <ul style="list-style-type: none"> <li>- any speed restriction below 40 km/h</li> <li>- information about any occupied track</li> <li>- information about any level crossing not protected</li> <li>- stopping location if it is not the next ETCS stop marker</li> <li>- information about <a href="#">possessions</a> or <a href="#">shunting areas</a>.</li> </ul>
3907	Signaller	<p>The Signaller must ensure that the continued driving of the <a href="#">train</a> remains protected until one of the following conditions is fulfilled:</p> <ul style="list-style-type: none"> <li>- the train has reached the <a href="#">end of authority</a> of <a href="#">Operational Instruction 7</a> and has changed into supervised driving</li> <li>- the <a href="#">Operational Instruction</a> is revoked by an Operational Instruction 3</li> <li>- the Driver reporting that the train is at a standstill at the end of authority of <a href="#">Operational Instruction 7</a> without a <a href="#">movement authority</a>.</li> </ul>
3908	Driver	<p>When the <a href="#">Operational Instruction 7</a> is completed, the Driver must check the location of the <a href="#">end of authority</a> of the <a href="#">Operational Instruction 7</a> either by using the <a href="#">Route Book</a> or by local area knowledge.</p> <p>The Driver is then authorised to press override to enter <a href="#">SR-mode</a> and proceed to the next ETCS stop marker, or the location instructed, using the information contained in the <a href="#">Operational Instruction 7</a>.</p> <p>If the movement ends in a <a href="#">possession</a> or <a href="#">shunting area</a>, the Driver may only start the movement according to <a href="#">Operational Instruction 7</a> when the movement inside the area has been agreed with the PICOP or Shunting area manager. The Driver must immediately after entering the area make sure that the <a href="#">onboard</a> changes to SH-mode.</p>

3909	Driver	<p>If <a href="#">Operational Instruction 7</a> contains additional information of a level crossing not protected, the Driver must stop in front of the level crossing and proceed on sight, however with a maximum of 10 km/h, while using sound signal "Warning", until the lead cab has passed the level crossing.</p> <p>The Driver may omit the use of sound signal "Warning", when staff present at the level crossing is applying the hand signal "road traffic, stop".</p>
2026	Driver	<p>If the <a href="#">train</a> reaches the next ETCS stop marker, or the location specified on the <a href="#">Operational Instruction</a>, and no <a href="#">movement authority</a> is received, the Driver must press the <a href="#">Start button</a> to request a movement authority.</p>
3787	Signaller	<p>If the <a href="#">train</a> has reached the next ETCS stop marker or the location specified on the <a href="#">Operational Instruction</a>, and it is still not possible to issue a <a href="#">movement authority</a> to the train, the Signaller must apply the procedure <a href="#">Degraded operation - Authorised passing of the end of authority</a>.</p>

## Normal operation

3807			
3808	Precondition		A train has been prepared for service. The train will transport hazardous goods.
3809	Purpose		Ensure that Banedanmark is informed of trains transporting hazardous goods. And that all affected Signallers are informed of this as necessary.
			<b><u>PROCEDURE</u></b>
3811	Railway Undertaking		<p>The Railway Undertaking must have a procedure which ensures that the wagon list of the <a href="#">train</a> is registered according to the method of reporting as specified.</p> <p>The registration must include:</p> <ul style="list-style-type: none"> <li>- location of the wagons in the train</li> <li>- wagon type if it cannot be deduced from the wagon number</li> <li>- UN number, RID class and packing group for each wagon</li> <li>- quantity of <a href="#">hazardous goods</a> on each wagon specified in kg or liters, according to RID</li> <li>- high consequence hazardous goods according to RID.</li> </ul> <p>If the train contains wagons which carry trailers, then the notification must also state whether this is tank or mixed goods transport.</p> <p>The Railway Undertaking must ensure that the Driver, as a minimum, has been provided with the information required by RID before starting the mission. It must be ensured that the train is not reported ready for departure to the Driver before the wagon list has been registered according to the method of reporting as specified.</p> <p>If the train includes wagons transporting hazardous goods with label 1, 1.5 or 1.6 (see appendix B) The Railway Undertaking must distinctly inform the Dispatcher about the train.</p> <p>If the train includes wagons transporting hazardous goods with label 1, 1.5 or 1.6 The Railway Undertaking must only report the train ready for departure to the driver, when the Dispatcher has reported that all affected Signallers have confirmed the receipt of the hazardous goods transport report.</p> <p>The Railway Undertaking must ensure that its relevant shunters, are informed if the wagons are provided with label 1, 1.5 or 1.6.</p>
3813	Dispatcher		If the wagons contain <a href="#">hazardous goods</a> marked with labels 1, 1.5 or 1.6 (see appendix B), the Dispatcher must ensure that all affected Signallers are informed of the <a href="#">train</a> before the Dispatcher confirms the receipt of the hazardous goods transport report to the Railway Undertaking.

- 3814      Signaller
- When the Signaller receives a report informing that a [train](#) is transporting [hazardous goods](#) with the labels 1, 1.5 or 1.6 (see appendix B), the Signaller must confirm the receipt of the report to the Dispatcher.
- The Signaller must ensure that the train transporting hazardous goods with the labels 1, 1.5 or 1.6 are reported in the [Signaller log](#).
- The Signaller must then ensure that the train is **NOT** allowed to depart before the Dispatcher confirms that all affected Signallers have confirmed the receipt of the train transporting hazardous goods with the label 1, 1.5 or 1.6 report.
- 3815      Dispatcher
- When the Dispatcher has received a confirmation from all affected Signallers, the Dispatcher must report to the Signaller responsible for the starting location of the [train](#) that all affected Signallers have confirmed and that the train may depart.
- This report must also be given to Signallers controlling locations where the train is planned to change consist.
- 3816      Signaller
- When the Dispatcher reports that all affected Signallers have confirmed the receipt of wagons transporting [hazardous goods](#) with the label 1, 1.5 or 1.6 report, the Signaller may allow the [train](#) to depart.

## Normal operation

3729			
3730	Precondition		A train has been prepared for service. The train will run with UT.
3731	Purpose		Ensure that all involved parties are informed that the train transports UT and ensuring that all restrictions in the UT transport permission are met.
			<b><u>PROCEDURE</u></b>
3733	Railway Undertaking		<p>The Railway Undertaking must ensure that the Signaller is informed about:</p> <ul style="list-style-type: none"> <li>- the Danish transport number of the UT transport permission</li> <li>- departure date and <a href="#">train running number</a></li> <li>- start and end location of the UT transport concerned.</li> </ul> <p>The Railway Undertaking must ensure that all applicable UT transport permissions have been handed over to the Driver prior to the start of the UT transport.</p> <p>In addition the Railway Undertaking must ensure that the <a href="#">train</a> is not reported ready for departure to the Driver until the Signaller has confirmed that the UT report is received.</p> <p>The Railway Undertaking is responsible for informing other Infrastructure Managers on the route of the train where UT operation is to take place.</p>
3734	Signaller		The Signaller in control of the area where the UT transport is scheduled to start must contact the Railway Undertaking and confirm that the UT report has been received.
3735	Signaller		<p>The Signaller must ensure that all affected Signallers are informed about the UT transport. The UT report must include:</p> <ul style="list-style-type: none"> <li>- the Danish number of the UT transport permission</li> <li>- departure date and <a href="#">train running number</a></li> <li>- start and end location of the UT transport.</li> </ul> <p>The Signaller may omit sending out the UT report if it is stated on the UT transport permission that the report can be omitted.</p>
3736	Signaller		When receiving a UT report, the Signaller must confirm that the report has been received to the Signaller that sent out the report.
3737	Signaller		The Signaller must ensure that the <a href="#">train</a> is not given permission to start the mission until all affected Signallers has confirmed that the UT report has been received.

## Normal operation

1990			<b>Beginning a mission</b>
1991	Precondition		The train is in SB-mode. Onboard train data entry has been successfully completed and the Driver is ready to begin the mission.
1992	Purpose		To supply the Driver with an appropriate driving mode according to train location.
			<b><u>PROCEDURE</u></b>
3084	Signaller, Driver		When the <a href="#">signalling system</a> registers a <a href="#">Start button</a> from a <a href="#">train</a> not yet on a mission, the signalling system will if possible provide the train with an <a href="#">OS MA</a> , if the train is located in or at the entrance to the <a href="#">interlocked area</a> . The OS MA will be updated when the conditions for an <a href="#">FS MA</a> are met.
1993	Driver		To request a <a href="#">movement authority</a> the Driver must press the <a href="#">Start button</a> .  The Driver must <b>NOT</b> press the start button if there are other <a href="#">trains</a> between the front end of the train and the first ETCS stop marker.
3085	Driver		If a <a href="#">movement authority</a> has not been received at the departure time indicated in the timetable, the Driver must contact the Signaller and request further instructions.
1996	Signaller		If the Signaller receives a request for an authority to move, the Signaller must provide the <a href="#">train</a> with the relevant authority to move.  If it is not possible to grant a <a href="#">movement authority</a> the Signaller must inform the Driver about an alternative departure.
1997	Signaller		If the expected <a href="#">train</a> is indicated with an invalid or unknown position on the <a href="#">signalling control display</a> , the Signaller must initiate the procedure <a href="#">Normal operation - Awakening with invalid or unknown position</a> .



## Normal operation

2030		<b>Train departure</b>
2031	Precondition	A supervised train is at a standstill. A driving mode is displayed on the DMI.
2032	Purpose	Ensure that trains are issued with movement authorities according to the timetable, and inform the Signaller when a movement authority is not available as expected.
		<b><u>PROCEDURE</u></b>
2033	Driver	The Driver must check that a <a href="#">movement authority</a> is displayed on the <a href="#">DMI</a> and that it is consistent with the departure time of the <a href="#">train</a> .
2034	Driver	If the Driver does not have a <a href="#">movement authority</a> displayed on the <a href="#">DMI</a> where one is expected, and there is no obvious reason for it to be withheld, the Driver must contact the Signaller.
2036	Signaller	If the Signaller receives a request for an authority to move, the Signaller must provide the <a href="#">train</a> with the relevant authority to move.  If it is not possible to grant a <a href="#">movement authority</a> the Signaller must inform the Driver about an alternative departure.
3556	Signaller	If a Driver reports that the <a href="#">train</a> does not have a <a href="#">movement authority</a> , the Signaller must investigate possible causes and set the conditions to allow a movement authority to be sent to the train.  If it is not possible to send a movement authority, the Signaller must apply the procedure <a href="#">Degraded operation - Authorised passing of the end of authority</a> .
3743	Driver	Before the <a href="#">train</a> departs, the Driver must check if there is a passenger crossing located between the front end of the train and the first ETCS stop marker.  If there is a passenger crossing located between the front end of the train and the first ETCS stop marker, the Driver must assume that the warning system is not activated and pass the crossing with caution.

## Normal operation

2047			<b>Arrival at scheduled stop</b>
2048	Precondition		The train is approaching a scheduled stopping location.
2049	Purpose		Stopping correctly at the stopping locations that are optimal for passenger loading at platforms, and at the end of authority for working units and freight trains.
			Avoid obstructing moveable elements or track sections behind the train.
			<b><u>PROCEDURE</u></b>
2050	Driver		The Driver must control the <a href="#">train</a> to a standstill at the <a href="#">scheduled stopping location</a> as indicated in the timetable.
2051	Railway Undertaking		The Railway Undertaking must have procedures enabling the Driver to always stop at the most optimal location according to the relevant type and length of <a href="#">rolling stock</a> . The stopping procedures must ensure that <a href="#">track sections</a> and <a href="#">moveable elements</a> behind the <a href="#">train</a> are not obstructed unnecessarily.
2052	Driver		Where the <a href="#">scheduled stopping location</a> is not at the <a href="#">end of authority</a> indicated on the <a href="#">DMI</a> , the Driver must control the <a href="#">train</a> to a standstill at the correct location along the platform according to Railway Undertaking procedures.
2053	Driver		Where the <a href="#">scheduled stopping location</a> is at the <a href="#">end of authority</a> indicated on the <a href="#">DMI</a> , the Driver must control the <a href="#">train</a> to a standstill at the end of authority according to Railway Undertaking procedures.
2054	Driver		If the <a href="#">Scheduled stopping location</a> is technical, the Driver must control the <a href="#">train</a> to a standstill at the <a href="#">end of authority</a> .
2056	Driver		If the next operational step is to continue as a <a href="#">train</a> the Driver must initiate the procedure <a href="#">Normal operation - Train departure</a> or <a href="#">Normal operation - Beginning a mission</a> .
			If the next operational step is not to continue as a train the Driver must initiate the procedure <a href="#">Normal operation - Rolling stock is not continuing as a train</a> or <a href="#">Shunting - Prepare shunting movement</a> .
			If the next operational step is unknown the Driver must apply the procedure <a href="#">Normal operation - Next operational step unknown</a> .

## Normal operation

2070

### Next operational step unknown

2071 Precondition

The train is at a standstill but not in a depot or at a stabling track. The timetable does not contain any further operations for the train.

2072 Purpose

Update the production plan to resume or end the mission of the train.

### PROCEDURE

2074 Signaller

The Signaller must in cooperation with the Dispatcher decide the next operational step required and inform the Driver if this deviates from any pre-agreed plan.

2075 Signaller

To resume or end the mission of the [train](#) the Signaller must ensure that the [production plan](#) is updated or use manual [route setting](#).

2076 Driver

The Driver must accept any valid changes to the pre-agreed plan as informed by the Signaller.

## Normal operation

2084			
2085	Precondition		One train is stationary and the associated route is released. Another train is approaching for joining.
2086	Purpose		Joining of trains according to the timetable.
			<b><u>PROCEDURE</u></b>
2089	Railway Undertaking		The Railway Undertaking must ensure procedures are available describing safe <a href="#">joining</a> and <a href="#">coupling</a> of specific <a href="#">rolling stock</a> .
2091	Driver		<p>The Driver must acknowledge OS-mode, and drive the <a href="#">train</a> into the occupied <a href="#">track section</a>. The Driver must control the train according to Railway Undertaking procedures to ensure safe <a href="#">joining</a> and <a href="#">coupling</a> of trains.</p> <p>After coupling, the Driver of the approaching train must close the desk of the cab.</p>
2092	Driver		After <a href="#">joining</a> the Driver shall prepare the new <a href="#">train</a> according to procedure <a href="#">Normal operation - Update onboard train data</a> .

## Normal operation

2102			
			<b>Planned splitting</b>
2103	Precondition		A train is approaching the location where the timetable indicates that planned splitting of the train is to be performed.
2104	Purpose		Splitting of train according to the timetable.
			<b><u>PROCEDURE</u></b>
2105	Railway Undertaking		The Railway Undertaking must have procedures describing the safe <a href="#">splitting</a> of <a href="#">rolling stock</a> .
2106	Driver		The Driver must perform <a href="#">train splitting</a> at the location indicated by the timetable. The Driver must follow Railway Undertaking procedures describing splitting of <a href="#">rolling stock</a> .
2107	Driver		If the <a href="#">train</a> is not at a standstill, when <a href="#">splitting</a> is performed, the Driver must bring the train to a standstill immediately after the split.
2108	Driver		The Driver is permitted to move the front part of the <a href="#">train</a> forward or move the rear part of the train backwards to achieve the physical split of the train, provided the Driver can prevent the release of the train doors.  The Driver may move the train up to 1 metre. If the Driver requires the train to move a distance greater than 1 metre, the Driver must contact the Signaller for authorisation.
2110	Driver		If the lead cab prior to the <a href="#">splitting</a> is still the lead cab on <a href="#">train</a> departure after the splitting, the Driver of the front train must update train data according to procedure <a href="#">Normal operation - Update onboard train data</a> .
2111	Driver		The Driver of all other cabs must follow the procedure <a href="#">Normal operation - Enter onboard train data after splitting</a> .

## Normal operation

2113			<b>Update onboard train data</b>
2114	Precondition		Updates to the train data are necessary. The train is at a standstill.
2115	Purpose		Ensuring that the onboard train data is always consistent with the characteristics and consist of the train.
			<b><u>PROCEDURE</u></b>
2116	Railway Undertaking		The Railway Undertaking must have a procedure that ensures that valid <a href="#">onboard train data</a> are made available to the Driver.
2117	Driver		The Driver must ensure that updated <a href="#">onboard train data</a> is available or entered in the <a href="#">onboard</a> . The Driver must verify that the onboard train data held by the onboard is correct.
2118	Driver		The Driver must ensure that any changes in the <a href="#">Railway Undertaking train data</a> are updated by initiating the procedure <a href="#">Normal operation - Railway Undertaking train data</a> .
2120	Driver		If the updated <a href="#">onboard train data</a> is valid for <a href="#">train</a> driving, but no <a href="#">movement authority</a> is displayed on the DMI, the Driver must apply the initiate the procedure <a href="#">Normal operation - Train departure</a> .
2121	Driver		If the updated <a href="#">onboard train data</a> is not valid for <a href="#">train</a> driving, the Driver must: <ol style="list-style-type: none"> <li>1. Contact the Signaller and inform about the situation</li> <li>2. Apply relevant Railway Undertaking procedure to determine next step.</li> </ol>
2122	Signaller		If the Signaller is informed that the new <a href="#">train</a> data does not allow the train to proceed, the Signaller must apply the procedure <a href="#">Train failure - Train and/or onboard failure during a mission</a> .

## Normal operation

2125			<b>Rolling stock is not continuing as a train</b>
2126	Precondition		A train has reached the last scheduled stopping location in the timetable. The rolling stock is not going to continue as a train.
2127	Purpose		To end the mission by closing down the lead desk and parking the train, or entering SH-mode to perform shunting movements.
			<b><u>PROCEDURE</u></b>
2128	Driver		When the <a href="#">train</a> has reached the last scheduled location in the timetable, the Driver must determine if the train should be parked at the current location or be prepared for shunting.
2129	Railway Undertaking		The Railway Undertaking must have procedures describing how the Driver can perform a safe <a href="#">parking</a> of rolling stock. This includes correct application of parking brakes for the rolling stock concerned to prevent any unintentional movement.
2130	Driver		If the next operational step is to park the <a href="#">train</a> at the current location, the Driver must close the desk and secure the parked rolling stock against any unintended movements according to Railway Undertaking procedures.
2132	Driver		If the next operational step is to prepare for shunting, the Driver must apply the procedure <a href="#">Shunting - Prepare shunting movement</a> .
2134	Driver		If the Driver is not able to determine the next operational step from the timetable, the Driver must contact the Railway Undertaking for further instructions.  If the Driver cannot obtain information about the next operational step from the Railway Undertaking, the Driver must contact the Signaller for further instructions.
2135	Signaller		If the Driver informs the Signaller that the next operational step cannot be determined, the Signaller must decide on the most convenient location to park the <a href="#">train</a> and inform the Driver.



## Normal operation

3103			<b>User worked crossing</b>
3104	Precondition		A member of the public request to use a user worked crossing.
3105	Purpose		Prevent use of a user worked crossing endangering the safe passage of trains.
			<b><u>PROCEDURE</u></b>
3107	Signaller		<p>For all <a href="#">user worked crossings</a> a predefined <a href="#">temporary speed restriction</a> of 0 km/h is available extending 50 metres both sides of the crossing.</p> <p>All user worked crossings are identified by a unique ID-number and the ID-numbers are available on the <a href="#">signalling control display</a> .</p>
3108	Signaller		<p>When receiving a request from a member of the public to pass a <a href="#">user worked crossing</a> the Signaller must obtain the location and identity of the crossing and verify that this corresponds to the user worked crossing.</p> <p>The Signaller must make an entry in the <a href="#">Signaller log</a> containing the ID-number of the user worked crossing, the name and phone number of the member of the public requesting to pass.</p>
3109	Signaller		If a <a href="#">train</a> is approaching the crossing the Signaller must instruct the member of the public to wait and call back when the train has passed.
3110	Signaller		If no <a href="#">train</a> is approaching the crossing the Signaller must activate a <a href="#">temporary speed restriction</a> of 0 km/h at the crossing by applying the predefined speed restriction identified by the ID-number of the <a href="#">user worked crossing</a> .
3111	Signaller		<p>When the signalling system indicates that the <a href="#">temporary speed restriction</a> of 0 km/h is active the Signaller must observe the <a href="#">signalling control display</a> to verify that the temporary speed restriction is activated at the requested <a href="#">user worked crossing</a>.</p> <p>The Signaller must instruct the member of the public to report back when the user worked crossing has been cleared and the gates closed.</p> <p>Then the Signaller may authorise the member of the public to cross at the user worked crossing.</p>
3112	Signaller		When the Signaller is informed by the member of the public that the <a href="#">user worked crossing</a> has been cleared the Signaller may remove the <a href="#">temporary speed restriction</a> for the user worked crossing.



- 3113      Signaller
- If the member of the public does not report back and the Signaller is unable to contact the member of the public, the Signaller may request assistance from the Driver of the next [train](#) approaching the crossing.
- The Signaller must instruct the Driver to complete an [Operational Instruction 6](#). The Operational Instruction 6 must include:
- an instruction to run [on sight](#)
  - location of the [user worked crossing](#)
  - additional instructions to bring the train to a standstill before reaching the user worked crossing and closing the gate
  - instruction to report back to the Signaller when the gate is closed.
- When the Driver has completed the Operational Instruction 6, the Signaller may deactivate the [temporary speed restriction](#) protecting the user worked crossing.
- 3114      Driver
- When the [Operational Instruction 6](#) is completed the Driver may proceed to the [user worked crossing](#), using the information contained in the Operational Instruction 6, and close the gate.
- The Driver must report back to the Signaller when the crossing gates have been closed.
- 3115      Driver
- When the gate is closed and the Signaller has been informed, the Driver may continue driving according to the [movement authority](#) displayed on the [DMI](#).

## Normal operation

3292			
			<b>Handling of TR-mode</b>
3293	Precondition		A train has entered TR-mode and the emergency brake is applied.
3294	Purpose		Resume driving after entering TR-mode.
			<b><u>PROCEDURE</u></b>
3295	Driver, Signaller		<p>When a <a href="#">train</a> exceeds the authority supervised by the <a href="#">onboard</a>, or an unsafe condition arises either in the <a href="#">signalling system</a> or detected by the onboard, or an emergency stop is issued from the signaller the onboard will enter <a href="#">TR-mode</a>. When the onboard enters TR-mode, the <a href="#">emergency brakes</a> will be applied bringing the train to a standstill. When the train is at a standstill the onboard automatically changes into acknowledge TR-mode.</p> <p>Trains entering into TR-mode are indicated to the Signaller on the <a href="#">signalling control display</a>.</p>
3296	Signaller		When a <a href="#">train</a> has entered <a href="#">TR-mode</a> due to exceeding its authority and poses a danger to other movement in the area, the Signaller must apply the procedure <a href="#">Emergency - Stop trains and vehicles from entering hazardous area</a> .
3297	Driver		When the <a href="#">train</a> enters <a href="#">TR-mode</a> , the Driver may acknowledge TR-mode once the train is at a standstill.
3298	Driver, Signaller		<p>When the Driver acknowledges <a href="#">TR-mode</a> the <a href="#">onboard</a> changes from TR-mode to <a href="#">PT-mode</a> and the symbol indicating PT-mode is displayed on the <a href="#">DMI</a>.</p> <p>Once in PT-mode, the <a href="#">emergency brake</a> is released enabling the Driver to continue once a new <a href="#">movement authority</a> is received.</p>
3299	Driver		<p>When the Driver has acknowledged <a href="#">TR-mode</a> the Driver must determine the reason for the entry into TR-mode and inform the Signaller.</p> <p>If the entry into TR-mode is caused by an <a href="#">onboard</a> failure the Driver must apply the procedure <a href="#">Train failure - Train and/or onboard failure during a mission</a>.</p> <p>If the <a href="#">train</a> is required to be moved the Driver must request the Signaller for permission to proceed.</p>

3300	Signaller	<p>When the Signaller is informed of an entry into <a href="#">TR-mode</a>, the Signaller must determine if the <a href="#">train</a> has entered TR-mode as a result of exceeding its own authority or if it is caused by another reason.</p> <p>If the train has exceeded its own authority, the Signaller must apply the procedure <a href="#">Incidents - Reporting incident</a>.</p> <p>If the train has been stopped because an emergency stop was sent, the Signaller must only allow the train to continue driving when it has been verified that it is safe to do so.</p> <p>If the train must continue driving, the Signaller must request the Driver to press the <a href="#">Start button</a>.</p>
3586	Driver	<p>When requested by the Signaller, the Driver must press the <a href="#">Start button</a> to request a <a href="#">movement authority</a> from the <a href="#">signalling system</a>. The Driver must report to the Signaller if a movement authority is received.</p>
3302	Signaller	<p>If the <a href="#">train</a> enters <a href="#">TR-mode</a> entering or exiting a <a href="#">possession</a>, temporary or <a href="#">permanent shunting area</a> the Signaller must obtain further information from the Shunter or PICOP before permitting the train to be moved.</p>
3587	Signaller	<p>If the Driver reports that a <a href="#">movement authority</a> is received, the Signaller may allow the Driver to continue driving according to the movement authority.</p> <p>If the Driver reports that no movement authority is received, the Signaller must ensure that:</p> <ol style="list-style-type: none"> <li>1. Moveable elements where authority to move on <a href="#">Operational Instruction 2</a> will be valid are detected in the correct lie and prevented from further throwing or any moveable elements where authority to move on Operational Instruction 2 will be valid are safe to pass according to the procedure Infrastructure fault -Handling of an undetected point that is not trailed, Infrastructure fault - Handling of a trailed point or location specific description</li> <li>2. The <a href="#">track section</a> where authority to move on Operational Instruction 2 will be valid is unoccupied, unless the Signaller requires the <a href="#">train</a> to enter an occupied track section, a <a href="#">possession</a> or a shunting area</li> <li>3. No other trains have authority to move within or into the track section where authority to move on Operational Instruction 2 will be valid</li> <li>4. No other trains have authority to move within or into the track section which follows the track section where authority to move on Operational Instruction 2 will be valid, unless the Operational Instruction 7 will apply to an occupied track section, a buffer stop, a possession or a shunting area</li> <li>5. Instruct the Driver to complete an Operational Instruction 2.</li> </ol>
3895	Signaller	<p>The Signaller must assess if any of the following restrictions apply to the continued driving of the <a href="#">train</a> on <a href="#">Operational Instruction 2</a>:</p> <ul style="list-style-type: none"> <li>- unusual transport restrictions,</li> <li>- electrical rolling stock,</li> <li>- restrictions specified in location specific descriptions.</li> </ul>

3896	Signaller	<p>If a level crossing is located between the <a href="#">train</a> and the <a href="#">end of authority</a> of the <a href="#">Operational Instruction 2</a>, the Signaller must apply the procedure <a href="#">Degraded operation - Passing a level crossing without a movement authority</a>.</p>
3897	Signaller	<p>If the Signaller requires the <a href="#">train</a> to enter an occupied track and it is not according to the production plan, the Signaller must inform the Driver (if relevant) of the occupying train that another train is to approach.</p>
3898	Signaller	<p>When the continued driving of the <a href="#">train</a> is protected, the Signaller must instruct the Driver to complete an <a href="#">Operational Instruction 2</a>. The Operational Instruction 2 must include (as required):</p> <ul style="list-style-type: none"> <li>- any speed restriction below 40 km/h</li> <li>- information about any occupied track</li> <li>- information about any level crossing not protected</li> <li>- stopping location if it is not the next ETCS stop marker</li> <li>- information about <a href="#">possessions</a> or shunting areas.</li> </ul>
3899	Signaller	<p>The Signaller must ensure that the continued driving of the <a href="#">train</a> remains protected until one of the following conditions is fulfilled:</p> <ul style="list-style-type: none"> <li>- the train has reached the <a href="#">end of authority</a> of <a href="#">Operational Instruction 2</a> and has changed into supervised driving</li> <li>- the Operational Instruction is revoked by an Operational Instruction 3</li> <li>- the Driver reporting that the train is at a standstill at the end of authority of Operational Instruction 2 without a <a href="#">movement authority</a>.</li> </ul>
3900	Driver	<p>When the <a href="#">Operational Instruction 2</a> is completed, the Driver must check the location of the <a href="#">end of authority</a> of the Operational Instruction 2 either by using the Route Book or by local area knowledge.</p> <p>The Driver is then authorised to press override to enter SR-mode and proceed to the next ETCS stop marker, or the location instructed, using the information contained in the Operational Instruction 2.</p> <p>If the movement ends in a <a href="#">possession</a> or shunting area, the Driver may only start the movement according to Operational Instruction 2 when the movement inside the area has been agreed with the PICOP or Shunting area manager. The Driver must immediately after entering the area make sure that the <a href="#">onboard</a> changes to <a href="#">SH-mode</a>.</p>
3901	Driver	<p>If <a href="#">Operational Instruction 2</a> contains additional information of a level crossing not protected, the Driver must stop in front of the level crossing and proceed on sight, however with a maximum of 10 km/h, while using sound signal "Warning", until the lead cab has passed the level crossing.</p> <p>The Driver may omit the use of sound signal "Warning", when staff present at the level crossing is applying the hand signal "road traffic, stop".</p>
3303	Signaller	<p>If no further movements are required the Signaller must instruct the Driver to close the driving desk by means of <a href="#">Operational Instruction 2</a> using the additional instructions section.</p>

## Normal operation

2138		<b>Driving into an occupied track section</b>
2139	Precondition	The Signaller needs to drive a train into an occupied track section. The trains are not coupling.
2140	Purpose	Allow two trains to occupy the same track section without coupling.
		<b><u>PROCEDURE</u></b>
3822	Signaller	The Signaller must ensure that the stationary <a href="#">train</a> remains at a standstill while the arriving train is running into the same <a href="#">track section</a> .
2141	Signaller	The Signaller must then inform the Driver of the arriving <a href="#">train</a> is informed that it will be routed into an occupied <a href="#">track section</a> , unless this has been agreed in advance with the Railway Undertaking.

## Normal operation

3224			<b>Parking in an interlocked area</b>
3225	Precondition		A need for an unplanned parking in an interlocked area has occurred.
3226	Purpose		To ensure the parking does not affect the production plan and this is updated with the changes.
			<b><u>PROCEDURE</u></b>
3227	Railway Undertaking		The Railway Undertaking must have procedures describing how the Driver can perform a safe <b>parking</b> of <b>rolling stock</b> in an <b>interlocked area</b> . This includes correct application of parking brakes for the concerned rolling stock to prevent any unintentional movement.
3228	Driver		The Driver must request the Signaller for permission to park <b>rolling stock</b> . .  The request must contain: <ul style="list-style-type: none"> <li>- length of the rolling stock</li> <li>- track number</li> <li>- expected <b>parking</b> duration</li> <li>- reason for parking.</li> </ul>
3230	Signaller		The Signaller must assess the request and decide if the <b>parking</b> can be approved.  If the request can be approved, the Signaller must ensure that the changes is updated in the <b>production plan</b> or it is noted in the Signaller log.  The Signaller then inform the Driver if the <b>train</b> can be parked and potentially issue a movement authority, to the track where parking have to take place.
3231	Signaller		If the request cannot be approved, the Signaller must inform the Driver and agree on an alternative.
3232	Driver		When the <b>train</b> has arrived at the agreed <b>parking track</b> , the Driver must secure the parked <b>rolling stock</b> against any unintended movements according to Railway Undertaking procedures.

## Normal operation

3364		<b>Supervised driving into a possession or shunting area</b>
3365	Precondition	A supervised train has to enter a possession or shunting area.
3366	Purpose	Ensure that the Shunting area manager has accepted the train before it is routed into the possession or shunting area.
<b><u>PROCEDURE</u></b>		
3367	Signaller, Shunting area manager	 <p>When <a href="#">route</a> setting into a <a href="#">possession</a> or <a href="#">shunting area</a> is requested, a request to accept or reject the <a href="#">train</a> is sent to the <a href="#">handheld terminal</a> of the Shunting area manager. The train will not receive a movement authority into the area before the Shunting area manager has accepted the request on the handheld terminal.</p> <p>If no handheld terminal is associated with the possession or shunting area a request to accept the train into the area may be indicated to the Signaller on the <a href="#">signalling control display</a>.</p>
3368	Shunting area manager	<p>When the <a href="#">Shunting area</a> manager is requested on the <a href="#">handheld terminal</a> , or by the Signaller, to accept a <a href="#">train</a> into the <a href="#">possession</a> or shunting area, the Shunting area manager must only accept the train when it is safe to do so.</p> <p>Prior to accepting the train into the possession or shunting area, the Shunting area manager must ensure that the Driver is instructed about the <a href="#">shunting movements</a> to be performed inside the area. The Shunting area manager must ensure that the Driver is informed about any special restrictions or precautions which apply to shunting movements in the area.</p>
3369	Signaller	<p>If a request to accept or reject a <a href="#">train</a> into a <a href="#">possession</a> or <a href="#">shunting area</a>, managed by a Shunting area manager without a <a href="#">handheld terminal</a>, is indicated on the <a href="#">signalling control display</a>, the Signaller must only accept the train into the area when permission from the Shunting area manager has been obtained.</p> <p>When driving into a permanent shunting area not managed by a Shunting area manager, the Signaller may allow driving into the area without further arrangements.</p>
3562	Signaller	<p>If a <a href="#">train</a> unintentionally stops during driving into a <a href="#">possession</a> or <a href="#">shunting area</a>, after changing to SH-mode, the Signaller may allow the Driver to resume driving into the area without further agreement from the Shunting area manager.</p>

## Normal operation

3151		<b>Driving with working unit</b>
3152	Precondition	The Driver of a working unit is ready to perform a movement.
3153	Purpose	To exchange information according to Operational Instruction 22 and, if required, plan the movement in the signalling system.
		<b><u>PROCEDURE</u></b>
3154	Driver	<p>The Driver must fill in part A of the “the Operational Instruction 22” form. In case the movement is done according to a pre-ordered timetable, the Driver may omit filling in information about location to start mission, preferred start time, destination and preferred arrival time.</p> <p>The Driver must then contact the Signaller and request the movement and hand over the information on part A of the form. In case the movement is done according to a pre-ordered timetable, the request must also contain the <a href="#">train running number</a>.</p>
3155	Signaller	When a Driver requests a <a href="#">working unit</a> move, the Signaller must complete part A on the Operational Instruction 22 according to the Driver’s request.
3158	Signaller	<p>If the movement is planned in advance, the Signaller must ensure that the information on part A of the form is consistent with the information in the <a href="#">signalling system</a>.</p> <p>If the movement is not planned in advance, the Signaller must ensure that the movement is planned in the signalling system.</p>
3159	Signaller	<p>If the movement is planned in advance, and it is ensured that the information on part A of the form and in the <a href="#">signalling system</a> is consistent, the Signaller must contact the Driver and confirm that the information in the signalling system is correct.</p> <p>If the movement is not planned in advance, the Signaller must ensure that part B of the form is completed and then contact the Driver to dictate the information from part B.</p>
3160	Driver	When the Signaller has confirmed that the information in the <a href="#">signalling system</a> is correct, or when part B of the form is completed according to the Signaller’s instructions, the Driver may apply procedure <a href="#">Normal operation - Enter onboard train data</a> .
3876	Signaller	If the <a href="#">working unit</a> has to exit out of the Signaller’s area of responsibility, the Signaller must hand over the content of part A of the form to the Signaller or <a href="#">Legacy Signaller</a> who will receive the working unit.



## Normal operation

3163		
		<b>Handling changes to operation</b>
3164	Precondition	A need to change the planned operation has occurred.
3165	Purpose	Ensure that changes to the operation are handled by the Dispatcher and are included in the production plan in collaboration with the Signaller, in accordance with the service agreement, and possibly in collaboration with the Network manager.
		<b><u>PROCEDURE</u></b>
3169	Signaller	<p>If the change can be handled in accordance with the service agreement, the Signaller must ensure that the <a href="#">production plan</a> is updated with the changes.</p> <p>If the change cannot be handled in accordance with the service agreement, the Signaller must inform the Dispatcher and in cooperation decide the next operational step.</p>
3557	Signaller	If the change in the <a href="#">production plan</a> results in a change in the line the <a href="#">train</a> drives or a change in the scheduled stopping locations, the Signaller must ensure that the Driver is informed about the changes.
3170	Signaller	<p>If the change in the <a href="#">production plan</a> results in an altered <a href="#">train</a> sequence out of the level 2 area, the Signaller must inform the <a href="#">Legacy signaller</a> of the level 0 or level ATC area about the change.</p> <p>If the change in the production plan results in an altered train sequence for a train entering or exiting a <a href="#">depot</a>, the Signaller must contact the person controlling the depot and coordinate necessary changes.</p>
3593	Signaller	The Signaller must ensure that other Signallers affected by the change are informed.

## Normal operation

2904			<h3>Handling of a low adhesion area</h3>
2905	Precondition		Trains are running under normal conditions. An area of the infrastructure has low adhesion.
2906	Purpose		To compensate for the low adhesion factor in order to reduce the risk of the train overrunning the end of authority.
			<h3><u>PROCEDURE</u></h3>
2908	Driver		<p>The Driver must inform the Signaller when they experience an area with <a href="#">low adhesion</a>, either unexpected for the time of year or in contrast with the general condition of the infrastructure at the location.</p> <p>The Driver may use the low adhesion controls on the <a href="#">onboard</a> equipment to modify the braking rate to the <a href="#">low adhesion setting</a>.</p>
2909	Driver, Signaller		<p>Activating a <a href="#">low adhesion</a> area will automatically command the <a href="#">low adhesion setting</a> of the <a href="#">onboard</a> of <a href="#">trains</a> passing the low adhesion area. When the low adhesion setting has been commanded by the <a href="#">signalling system</a>, the Driver cannot cancel the setting.</p>
2910	Signaller		If informed about an area with <a href="#">low adhesion</a> the Signaller must activate any associated low adhesion area in the <a href="#">signalling system</a> .
2913	Signaller		<p>Before an area with <a href="#">low adhesion</a> can be de-activated, the Signaller must request the Driver of one <a href="#">train</a> pr. track in the area to check whether they still experience low adhesion in the area.</p> <p>When the Driver(s) has reported that they no longer experience low adhesion in the area, the Signaller must de-activate the <a href="#">low adhesion setting</a> in the <a href="#">signalling system</a>.</p>
3782	Driver		When the <a href="#">low adhesion setting</a> on the <a href="#">train</a> is activated by the Driver, the setting may be de-activated by the Driver once they assess that the setting is no longer required.

## Normal operation

3911			<h3>Handling of area with data radio hole</h3>
3912	Precondition		A train is stopped and the text message "Communication error", and/or the data radio communication failure symbol is displayed in the DMI and the Signaller is informed, or a need for an announced data radio hole arises due to infrastructure work.
3913	Purpose		Ensure that the Signaller is notified of a data radio hole, and assess whether an announced data radio hole should be activated in the signalling system.
			<h3><u>PROCEDURE</u></h3>
3915	Driver		<p>If the lack of data radio communication is due to a fault on the train or the onboard, the Driver must use the procedure <a href="#">Train failure - Train and/or onboard failure during a mission</a>.</p> <p>If it is not possible to establish a connection to the radio block centre, the Driver must inform the Signaller.</p>
3916	Signaller		If connection to the radio block centre cannot be established, the Signaller must use the procedure <a href="#">Degraded operation - Authorised passing of the end of authority</a> and drive the train on to an area where it is again possible to establish connection to the radio block centre.
3917	Signaller		When the Signaller is informed of an area with an <a href="#">unannounced data radio hole</a> , the Signaller must assess whether to activate an announced <a href="#">data radio hole</a> in the signalling system. The Signaller must do this in close cooperation with the O&M coordinator.
3918	Signaller		If the O&M coordinator informs the Signaller of a <a href="#">data radio hole</a> , the Signaller must activate an announced data radio hole according to the instructions of the O&M coordinator.
3919	Driver, Signaller		When a <a href="#">data radio hole</a> is activated in the signalling system, the onboard in trains running through the area will automatically stop monitoring the data radio communication until the entire train is out of the area.
3920	Signaller		<p>When an announced <a href="#">data radio hole</a> has been activated, the Signaller must ensure that no manual route release or shortening of movement authorities is carried out within the area, unless the Signaller has ensured that the train is at a standstill and an Operational Instruction 3 has been issued.</p> <p>The Signaller must inform the Driver to close the desk using the "Additional instructions" section of Operational Instruction 3.</p> <p>If it is not possible to send a new movement authority to the train, the Signaller must use the procedure <a href="#">Degraded operation - Authorised passing of the end of authority</a>.</p>
3921	Signaller		<p>Before an announced <a href="#">data radio hole</a> can be deactivated, the Signaller must, upon information from the O&amp;M coordinator, ensure that there is data radio communication in the area again.</p> <p>The Signaller must then deactivate the announced data radio hole.</p>

## Normal operation

3525			
3526	Precondition		A relieving Signaller is ready to take over a part or the whole area from a responsible Signaller.
3489	Purpose		To ensure that the relevant information is given to the relieving Signaller and responsibility is transferred safely.
			<b><u>PROCEDURE</u></b>
3491	Signaller		The <a href="#">signalling system</a> will always require a Signaller to be responsible for each part of the interlocked infrastructure. Areas can be combined to cover a larger part of the infrastructure.
3492	Signaller		The relieving Signaller must read relevant entries in the <a href="#">Signaller log</a> and request relevant information not contained in the Signaller log from the responsible Signaller.
3494	Signaller		When a Signaller is requested to give up responsibility of an area the Signaller must provide the relieving Signaller with any relevant information regarding operations.  The Signaller must ensure that it is recorded when the responsibility for an area is handed over.
3800	Signaller		When the handover of responsibility for the area is performed and it is recorded, that relevant notes in the <a href="#">Signaller log</a> have been read the Signaller may operate the <a href="#">signalling system</a> .

## Normal operation

3139			
			<b>Operating a bascule bridge</b>
3140	Precondition		The Bridge guard needs to operate the bridge.
3141	Purpose		Ensure that the Bridge guard can operate the bridge without affecting operations and it is agreed with the PICOP, if there is a possession on the bridge.
			<b><u>PROCEDURE</u></b>
3143	Bridge guard		The Bridge guard must request the bridge released for operation and provide the Signaller with any necessary information.
3819	Bridge guard		If a possession is established on the bridge, the Bridge guard must contact the Signaller to request authority to release the bridge for operation themselves.
3820	Signaller		If a possession is established on the bridge, the Signaller must contact the PICOP and request permission to release the bridge for operation by the Bridge guard. The Signaller may only allow the Bridge guard to operate the bridge for operation when the PICOP has given authority to do so.
3144	Signaller		When the release of a <b>bascule bridge</b> is requested the Signaller must decide on a convenient time to release the bridge.
3145	Signaller		When the Signaller has decided on a convenient timeslot, the Signaller may acknowledge the request.
			When the agreed timing arrangements are met, and it is still appropriate to release the bridge, the Signaller must acknowledge the release of the bridge, handing over responsibility for the bridge to the Bridge guard.
3821	Bridge guard		If a possession is established on the bridge, the Bridge guard may release the bridge for operation themselves when the Signaller has given permission to do so.
3146	Bridge guard		When the Signaller has released the bridge, the Bridge guard may operate the bridge.
3147	Signaller, Bridge guard		Once the bridge guard has returned the bridge to its normal position, the bridge is locked and the release of the bridge is automatically revoked by the <b>signalling system</b> .
3148	Bridge guard		When it is no longer required to have the bridge open, the Bridge guard must return the bridge to its normal position.
			If a possession is established on the bridge, the Bridge guard must contact the Signaller and report when the bridge is back to its normal position.
3894	Signaller		When the Bridge guard reports that the bridge is back to its normal position, the Signaller must inform the PICOP.

3184		<b>Level transition</b>
3185		<b>Unsupervised level transition into a level 2 area</b>
3186	Precondition	It is not possible to clear the signal to the transition area from the level 0 or level ATC area. The train is ready to perform an unsupervised level transition into a level 2 area.
3187	Purpose	For the Signaller to ensure adequate protection for a route to permit the Legacy signaller to authorise the train to approach the system border. Furthermore, for the Signaller to authorise the train to proceed to the first ETCS stop marker.
		<b><u>PROCEDURE</u></b>
3188	Signaller	When the <u>Legacy signaller</u> requests permission to verbally authorise a <u>train</u> to approach the <u>system border</u> , the Signaller must protect the <u>transition area</u> .
		The Signaller must protect the transition area by ensuring that no train or <u>vehicle</u> has authority to move within or into the track section between the system border and the first <u>ETCS stop marker</u> .
3189	Signaller	When the <u>transition area</u> is protected, the Signaller must inform the <u>Legacy signaller</u> , that the <u>train</u> can approach the <u>system border</u> .
3588	Driver	When the <u>train</u> is at a standstill at the <u>system border</u> , the Driver must apply the procedure <u>Degraded operation - Authorised passing of the end of authority</u> .
3589	Driver	If the <u>train</u> passes the <u>system border</u> , without changing into <u>level 2</u> , the Driver must continue to the <u>end of authority</u> of the <u>Operational Instruction 1</u> and inform the Signaller.

## Level transition

3193		<b>Unsupervised level transition from a level 2 area</b>
3194	Precondition	It is not possible to issue a movement authority to the transition area. The train is ready to perform an unsupervised transition from a level 2 area.
3195	Purpose	For the Signaller to ensure adequate protection for a route before issuing an Operational Instruction 1 to approach the system border.
		<b><u>PROCEDURE</u></b>
3196	Driver	When the train is at a standstill in front of the last <a href="#">ETCS stop marker</a> protecting the <a href="#">transition area</a> , the Driver must apply the procedure <a href="#">Degraded operation - Authorised passing of the end of authority</a> .
3197	Signaller	The Signaller must contact the <a href="#">Legacy signaller</a> and request that the <a href="#">transition area</a> is protected.
3198	Signaller	When the <a href="#">Legacy signaller</a> reports that the <a href="#">transition area</a> is protected, the Signaller must apply the procedure <a href="#">Degraded operation - Authorised passing of the end of authority</a> .  The Signaller must ensure that the <a href="#">system border</a> is included as the <a href="#">end of authority</a> on the <a href="#">Operational Instruction 1</a> .
3590	Driver	When the train is at a standstill at the <a href="#">system border</a> , the Driver must contact the <a href="#">Legacy signaller</a> for instructions on how to proceed.

3458		<b>Crossover</b>
3459		<b>Shunting from Fjernbane to S-bane</b>
3460	Precondition	A train or vehicle is ready to perform a shunting movement from Fjernbane to S-bane.
3461	Purpose	For the Signaller to ensure adequate protection for the area and subsequently authorise the Shunting Area Manager to allow a shunting movement to S-bane in cooperation with the S-bane Signaller.
		<b><u>PROCEDURE</u></b>
3462	Shunting area manager	The Shunting area manager must contact the Signaller and request a <a href="#">temporary shunting area</a> in order to cross over to S-bane.
3464	Signaller	When the Signaller is requested by a Shunting area manager to establish a <a href="#">temporary shunting area</a> in order cross over to S-bane, the Signaller must contact the S-bane Signaller controlling the area and arrange the timing of the crossover.  The Signaller must inform the Shunting area manager about the planned timing.
3870	Shunting area manager	The Shunting area manager must ensure that a <a href="#">temporary shunting area</a> is planned starting from the position of the <a href="#">vehicle</a> to the <a href="#">system border</a> towards S-bane according to the procedure Shunting - Planning a temporary shunting area.
3871	Shunting area manager	Before the planned timing for the <a href="#">shunting movement</a> the Shunting area manager must establish the <a href="#">temporary shunting area</a> according to the procedure Shunting - Establish temporary shunting area with a handheld terminal or Shunting - Establish temporary shunting area without a handheld terminal.
3465	Signaller	When the S-bane Signaller has confirmed that the <a href="#">vehicle</a> is allowed to shunt towards S-bane the Signaller must give the Shunting area manager permission to shunt to the <a href="#">system border</a> towards S-bane.



## Crossover

3481		<b>Shunting from S-bane to Fjernbane</b>
3482	Precondition	A train or vehicle is requested to perform a shunting movement from S-bane to Fjernbane.
3483	Purpose	For the Signaller to ensure adequate protection for the area to enable the S-bane Signaller to authorise the train or working unit to perform a shunting movement to cross over to Fjernbane.
		<b><u>PROCEDURE</u></b>
3485	Signaller	When the S-bane Signaller requests that a <a href="#">vehicle</a> crosses over to Fjernbane, the Signaller must plan a timing with the S-bane Signaller.
3866	Shunting area manager	The Shunting Area Manager must ensure that a <a href="#">temporary shunting area</a> is planned according to the procedure Shunting - Planning a temporary shunting area.  The temporary shunting area must start at the <a href="#">system border</a> from S-bane.
3867	Shunting area manager	Before the planned timing for the <a href="#">shunting movement</a> the Shunting Area Manager must establish the <a href="#">temporary shunting area</a> according to the procedure Shunting - Establish temporary shunting area with a handheld terminal or Shunting - Establish temporary shunting area without a handheld terminal.
3868	Signaller	When the <a href="#">temporary shunting area</a> is established the Signaller may allow the S-bane Signaller to authorise the <a href="#">shunting movement</a> of the <a href="#">vehicle</a> to the <a href="#">system border</a> to Fjernbane.
3486	Shunting area manager	Before the <a href="#">train</a> or <a href="#">vehicle</a> passes the transition point to fjernbane the Shunting Area Manager must contact the Signaller to request permission to cross the <a href="#">system border</a> from S-bane.
3869	Signaller	When the Shunting Area Manager request permission to pass the <a href="#">system border</a> from S-bane the Signaller must give permission to cross the transition point from S-bane and shunt to the <a href="#">temporary shunting area</a> , if it is safe to do so.

2731		<b>Degraded operation</b>
2732		<b>Authorised passing of the end of authority</b>
2733	Precondition	It is not possible to issue a movement authority. The train is at a standstill and voice communication has been established between the Driver and the Signaller.
2734	Purpose	For the Signaller to ensure adequate protection to allow the train to continue driving and authorise the Driver to pass the end of authority by use of Operational Instruction 1.
		<b><u>PROCEDURE</u></b>
2735	Driver	The Driver must report current location to the Signaller and request authority to proceed.
2736	Signaller	When the Signaller has exhausted all possibilities for issuing a <a href="#">movement authority</a> , the Signaller must protect the continued driving of the <a href="#">train</a> and authorise the Driver to proceed past the <a href="#">end of authority</a> and to the next <a href="#">ETCS stop marker</a> , or other unambiguous location.
		To allow the continued driving of the train, the Signaller must ensure that:
		<ol style="list-style-type: none"> <li>1. <a href="#">Moveable elements</a> where <a href="#">authority to move</a> on <a href="#">Operational Instruction 1</a> will be valid are detected in the <a href="#">correct lie</a> and prevented from further throwing or any moveable elements where authority to move on Operational Instruction 1 will be valid are safe to pass according to the procedure Infrastructure fault -Handling of an <a href="#">undetected point</a> that is not trailed, <a href="#">Infrastructure fault - Handling of a trailed point</a> or <a href="#">location specific description</a></li> <li>2. The <a href="#">track section</a> where authority to move on Operational Instruction 1 will be valid is unoccupied, unless the Signaller requires the train to enter an occupied track section, a <a href="#">possession</a> or a <a href="#">shunting area</a></li> <li>3. No other trains have authority to move within or into the track section where authority to move on Operational Instruction 1 will be valid</li> <li>4. No other trains have authority to move within or into the track section which follows the track section where authority to move on Operational Instruction 1 will be valid, unless the Operational Instruction 1 will apply to an occupied track section, a buffer stop, a possession or a shunting area.</li> </ol>
2737	Signaller	<p>The Signaller must assess if any of the following restrictions apply to the continued driving of the <a href="#">train</a> on <a href="#">Operational Instruction 1</a>:</p> <ul style="list-style-type: none"> <li>- <a href="#">unusual transport</a> restrictions,</li> <li>- electrical rolling stock,</li> <li>- restrictions specified in <a href="#">location specific descriptions</a>.</li> </ul>
2738	Signaller	If a <a href="#">level crossing</a> is located between the <a href="#">train</a> and the <a href="#">end of authority</a> of the <a href="#">Operational Instruction 1</a> , the Signaller must apply the procedure <a href="#">Degraded operation - Passing a level crossing without a movement authority</a> .
2739	Signaller	If the Signaller requires the <a href="#">train</a> to enter an occupied track and it is not according to the production plan, the Signaller must inform the Driver (if relevant) of the occupying train that another train is to approach.

3772	Signaller	<p>If the Signaller wants to authorise the <a href="#">train</a> into a <a href="#">possession</a> or <a href="#">shunting area</a>, the Signaller must first contact the PICOP or Shunting area manager (if relevant) and request permission for the movement.</p>
2740	Signaller	<p>When the continued driving of the <a href="#">train</a> is protected, the Signaller must instruct the Driver to complete an <a href="#">Operational Instruction 1</a>. The Operational Instruction 1 must include (as required):</p> <ul style="list-style-type: none"> <li>- any speed restriction below 40 km/h</li> <li>- information about any occupied track</li> <li>- information about any <a href="#">level crossing</a> not protected</li> <li>- stopping location if it is not the next <a href="#">ETCS stop marker</a></li> <li>- information about <a href="#">possessions</a> or <a href="#">shunting areas</a>.</li> </ul>
2743	Signaller	<p>The Signaller must ensure that the continued driving of the <a href="#">train</a> remains protected until one of the following conditions is fulfilled:</p> <ul style="list-style-type: none"> <li>- the train has reached the <a href="#">end of authority</a> of <a href="#">Operational Instruction 1</a> and has changed into supervised driving</li> <li>- the <a href="#">Operational Instruction</a> is revoked by an <a href="#">Operational Instruction 3</a></li> <li>- the Driver reporting that the train is at a standstill at the end of authority of Operational Instruction 1 without a <a href="#">movement authority</a>.</li> </ul>
2744	Driver	<p>When the <a href="#">Operational Instruction 1</a> is completed, the Driver must check the location of the <a href="#">end of authority</a> of the Operational Instruction 1 either by using the <a href="#">Route Book</a> or by local area knowledge.</p> <p>The Driver is then authorised to press override to enter <a href="#">SR-mode</a> and proceed to the next <a href="#">ETCS stop marker</a>, or the location instructed, using the information contained in the Operational Instruction 1.</p> <p>If the movement ends in a <a href="#">possession</a> or <a href="#">shunting area</a>, the Driver may only start the movement according to Operational Instruction 1 when the movement inside the area has been agreed with the PICOP or Shunting area manager. The Driver must immediately after entering the area make sure that the onboard changes to SH-mode.</p>
2745	Driver	<p>If <a href="#">Operational Instruction 1</a> contains additional information of a <a href="#">level crossing</a> not protected, the Driver must stop in front of the level crossing and proceed <a href="#">on sight</a>, however with a maximum of 10 km/h, while using sound signal "Warning", until the lead cab has passed the level crossing.</p> <p>The Driver may omit the use of sound signal "Warning", when staff present at the level crossing is applying the hand signal "road traffic, stop".</p>

## Degraded operation

2775			<b>Passing a level crossing without a movement authority</b>
2776	Precondition		The Signaller needs to issue an Operational Instruction 1. A train is at standstill at an ETCS stop marker protecting a level crossing. Communication between the Driver and Signaller has been established.
2777	Purpose		Setup conditions to allow the Signaller to authorise the Driver to pass a level crossing.
			<b><u>PROCEDURE</u></b>
2779	Signaller		All <a href="#">level crossings</a> can be manually controlled by the Signaller and from a local control box.  Level crossings are automatically de-activated following <a href="#">train</a> passage both when activated by an automatic and a manual activation unless specifically ordered to remain activated or activated due to other conditions.
2780	Signaller		The Signaller must activate the <a href="#">level crossing</a> by performing one of the following actions:  - setting a <a href="#">route</a> through the level crossing - manually controlling the level crossing - requesting the Driver to activate the level crossing from the local control box.
3083	Driver		If requested by the Signaller the Driver must attempt to activate the <a href="#">level crossing</a> by using the local control box of the level crossing.  The Driver must observe the status of the level crossing from the indication in the local control box, and report to the Signaller.
2781	Signaller		When the <a href="#">level crossing</a> is activated, the Signaller must observe indications on the <a href="#">signalling control display</a> to determine if the level crossing is protected correctly.  If the level crossing is not protected the Signaller must ensure that the information is contained in the "Additional instructions" part of <a href="#">Operational Instruction 1</a> , <a href="#">Operational Instruction 2</a> or <a href="#">Operational Instruction 7</a> .
2786	Signaller		When the entire <a href="#">train</a> has passed the <a href="#">level crossing</a> , the Signaller must ensure the level crossing is deactivated.

## Degraded operation

3091			<b>Supervised passing of failed level crossing</b>
3092	Precondition		A supervised train is approaching a level crossing.
3093	Purpose		To pass a level crossing not automatically activated by the signalling system without causing any harm to infrastructure, rolling stock, passengers or road users.
			<b><u>PROCEDURE</u></b>
3094	Driver, Signaller		All <a href="#">level crossings</a> are equipped with a local control box enabling on site operation of the level crossing. The local control box is used in case of failures, fault correction or planned maintenance.
3095	Driver		<p>When the <a href="#">train</a> is supervised to a speed restriction of 10 km/h, and the <a href="#">unprotected level crossing</a> symbol is displayed on the <a href="#">DMI</a>, the Driver must bring the train to a standstill in front of the <a href="#">level crossing</a> and inform the Signaller.</p> <p>The information must include the ID number of the level crossing and, if possible, the nature of the fault.</p>
3096	Signaller		<p>When the Signaller is informed by a Driver that the <a href="#">train</a> is at a standstill at an <a href="#">unprotected level crossing</a>, the Signaller must try to operate the <a href="#">level crossing</a> manually.</p> <p>If the level crossing cannot be operated manually, the Signaller must request the Driver to operate the level crossing using the local control box.</p> <p>If the level crossing cannot be operated using the local control box, the Signaller must instruct the Driver to pass the unprotected level crossing using a verbal safety message.</p> <p>The verbal safety message must include <a href="#">train running number</a> and level crossing ID.</p>
3097	Signaller		<p>If the Signaller knows that the <a href="#">level crossing</a> cannot be operated manually by using the manual controls or the local control box, the Signaller may omit the process for manual activation and instruct the Driver to pass the <a href="#">unprotected level crossing</a> using a verbal safety message.</p> <p>The verbal safety message must include <a href="#">train running number</a> and level crossing ID.</p>
3098	Driver		<p>The Driver may continue driving if the <a href="#">level crossing</a> speed restriction of 10 km/h is lifted.</p> <p>When instructed by the Signaller to operate the level crossing, the Driver must use the local control box.</p> <p>If the level crossing cannot be protected, the Driver must inform the Signaller.</p>

3099 Driver

When the Signaller has authorised the passing an [unprotected level crossing](#) by a verbal safety message, the Driver must pass the [level crossing on sight](#) using sound signal "Warning" until the lead cab has passed the level crossing.

The Driver may omit the use of sound signal "Warning", when staff present at the level crossing is applying the hand signal "road traffic, stop".

3100 Signaller

If the [level crossing](#) cannot be protected automatically or manually, the Signaller must apply the procedure [Infrastructure fault - Handling report of infrastructure fault](#).

## Degraded operation

3255			<b>Overrunning/routed in wrong direction</b>
3256	Precondition		A train has overrun its scheduled stopping location or is routed in a wrong direction and is at a standstill.
3257	Purpose		To assess if the train will remain at the current location, continue, or be moved to another location.
			<b><u>PROCEDURE</u></b>
3258	Railway Undertaking		The Railway Undertaking must have procedures describing if <a href="#">backwards movements</a> are permitted with non passenger <a href="#">trains</a> .
3259	Driver		If a <a href="#">scheduled stopping location</a> is overrun or a <a href="#">train</a> is routed in the wrong direction the Driver must inform the Signaller, providing additional information regarding the actual location of the train and any expected delays to current operations.
3260	Signaller		When informed of an overrun, or a <a href="#">train</a> routed in a wrong direction, the Signaller must in close cooperation with the Driver determine the appropriate response.  The Signaller must determine if: <ul style="list-style-type: none"> <li>- the passengers may be exchanged without moving the train</li> <li>- the train must continue</li> <li>- the Driver must be instructed to close the desk and perform train awakening in the other end of the train</li> <li>- the train must perform a <a href="#">backwards movement</a> (provided that the train is not a passenger train).</li> </ul>
3261	Signaller		The Signaller must instruct the Driver about how to proceed.
3262	Signaller		If the <a href="#">train</a> has to perform a <a href="#">backwards movement</a> , and the train does not carry passengers, the Signaller must: <ul style="list-style-type: none"> <li>- disable automatic <a href="#">route setting</a></li> <li>- revoke any <a href="#">movement authority</a> into the area behind the train</li> <li>- ensure no train or <a href="#">vehicle</a> has <a href="#">authority to move</a> into the necessary <a href="#">track section(s)</a> behind the train</li> <li>- establish a <a href="#">temporary shunting area</a> around the train, or set a <a href="#">route for shunting</a>, to allow the backwards movement</li> <li>- instruct the Driver to complete an Operational Instruction 21.</li> </ul>
3263	Driver		When instructed by the Signaller, the Driver must complete Operational Instruction 21, provided that <a href="#">backwards movements</a> are permitted by the Railway Undertaking.  When Operational Instruction 21 is completed, the Driver must press "Shunt" to enter <a href="#">SH-mode</a> and perform the movement as instructed. The Driver must inform the Signaller when the movement is completed, and the <a href="#">train</a> is at a standstill.

- 3264      Signaller
- When the Driver informs the Signaller that the [backwards movement](#) is completed, and the [train](#) is at a standstill, the Signaller must instruct the Driver to [exit SH-mode](#) and prepare the train to continue its mission.
- When the train has exited [SH-mode](#), the Signaller must end the [temporary shunting area](#), or ensure the entire [route for shunting](#) is released, as applicable.
- 3561      Driver
- When instructed by the Signaller, the Driver must [exit SH-mode](#) and initiate the procedure [Normal operation - Enter onboard train data](#) to continue the mission.



## Degraded operation

2721			<b>Detect and log trailed point</b>
2722	Precondition		A point has been trailed.
2723	Purpose		Stopping traffic in the affected area and ensure trailing and operational constraints are logged in the Signaller log.
			<b><u>PROCEDURE</u></b>
2724	Driver		If the Driver of a <a href="#">train</a> or <a href="#">vehicle</a> observes the trailing of a point, the Driver must immediately stop the train or vehicle, and report the <a href="#">incident</a> to the Signaller.
3591	Shunter		If the Shunter observes the trailing of a point, the Shunter must instruct the Driver of the shunting movement to stop immediately, and report the <a href="#">incident</a> to the Signaller.
2725	Signaller		When a point with a <a href="#">point machine</a> operated by interlocking is detected trailed the <a href="#">signalling system</a> will revoke any related movement authorities and an alarm is raised to the Signaller on the <a href="#">signalling control display</a> .
2726	Signaller		The Signaller must react on the reported trailing by bringing all movements to a stop applying procedure <a href="#">Emergency - Stop trains and vehicles from entering hazardous area</a> .
2728	Signaller		When all <a href="#">trains</a> and <a href="#">vehicles</a> are at standstill the Signaller must apply the procedure <a href="#">Infrastructure fault - Handling report of infrastructure fault</a> .
2729	Signaller		The Signaller must ensure the <a href="#">trailed point</a> is logged in the <a href="#">Signaller log</a> and any connected operational constraints are recorded.

3563			<h2>Speed restriction</h2>
3564			<h3>Activate planned temporary speed restriction</h3>
3565	Precondition		A temporary speed restriction has been planned in the signalling system.
3566	Purpose		To establish the temporary speed restriction to ensure that all supervised trains are supervised according to the temporary speed restriction, and updating the Signaller log.
			<b><u>PROCEDURE</u></b>
3784	Maintainer		<p>When the Maintainer wishes to activate a planned <a href="#">temporary speed restriction</a>, the Maintainer must contact the Signaller and request activation.</p> <p>The request must contain the speed restriction ID, applicable speed and the location.</p>
3568	Signaller		<p>When the Maintainer requests the activation of a planned <a href="#">temporary speed restriction</a>, the Signaller must check that the requested speed restriction ID is shown on the overview of planned temporary speed restrictions.</p> <p>Prior to activating the speed restriction, the Signaller must ensure that:</p> <ul style="list-style-type: none"> <li>- no supervised trains are currently running in the area</li> <li>- the Driver of any unsupervised movement in the area is informed when the speed restriction is below 40 km/h</li> <li>- the Shunter of any shunting movement in the area is informed when the speed restriction is below 25 km/h.</li> </ul>
3840	Signaller		<p>The Signaller must then check that the indication of the speed restriction on the <a href="#">signalling control display</a> is consistent with the planning. If the indication is consistent with the planning, the Signaller must activate the speed restriction in the <a href="#">signalling system</a>.</p> <p>If the indication of the speed restriction on the signalling control display is <b>NOT</b> consistent with the planning, the Signaller must ensure that the speed restriction is updated in the signalling system according to the planning.</p>
3569	Signaller		<p>When the <a href="#">temporary speed restriction</a> is activated and indicated on the <a href="#">signalling control display</a>, the Signaller must ensure entry in the <a href="#">Signaller log</a>.</p> <p>The entry must include the applicable speed, name of the person requesting the activation of the speed restriction and the location where the speed restriction applies.</p>
3570	Signaller		If the Signaller knows that the planned <a href="#">temporary speed restriction</a> is not needed, or is faulty, the Signaller must reject the request and inform the O&M coordinator.

## Speed restriction

3573		<b>Deactivate temporary speed restriction</b>
3574	Precondition	There is no longer a need for a temporary speed restriction.
3575	Purpose	To deactivate the temporary speed restriction and ensure the Signaller log is updated.
		<b><u>PROCEDURE</u></b>
3785	Maintainer	<p>When there is no longer a need for a <a href="#">temporary speed restriction</a>, the Maintainer must contact the Signaller and request the speed restriction de-activated.</p> <p>The request must contain the speed restriction ID.</p>
3578	O&M coordinator	If the O&M coordinator is informed that a <a href="#">temporary speed restriction</a> cannot be deactivated safely, the O&M coordinator must inform the Signaller.
3577	Signaller	<p>When the Maintainer requests the de-activation of a <a href="#">temporary speed restriction</a>, the Signaller must assess if it can be de-activated safely.</p> <p>If the speed restriction can be de-activated safely, the Signaller must deactivate the speed restriction in the <a href="#">signalling system</a>.</p> <p>If the speed restriction cannot be de-activated safely, the Signaller must reject the request and inform the O&amp;M coordinator.</p>
3824	Signaller	When the <a href="#">temporary speed restriction</a> is de-activated and no longer indicated on the <a href="#">signalling control display</a> , the Signaller must ensure it is noted in the <a href="#">Signaller log</a> . The note must include the name of the person requesting the de-activation.

## Speed restriction

### 3268 Inform Driver of an unplanned speed restriction

3269 **Precondition** The Driver of an unsupervised train is instructed to stop due to an unplanned speed restriction below 40 km/h.

3270 **Purpose** To ensure that the unsupervised trains do not exceed the unplanned speed restriction speed.

### **PROCEDURE**

3271 **Driver** The Driver must report to the Signaller when the [train](#) is at a standstill.

3272 **Signaller** When the Signaller is informed by the Driver that the [train](#) is at a standstill, the Signaller must issue a new [Operational Instruction 1](#) that will revoke the current Operational Instruction 1 and containing the new speed restriction.

## Speed restriction

2699		<b>Handling an unplanned speed restriction</b>
2700	Precondition	The need for an unplanned speed restriction is reported to the Signaller.
2701	Purpose	Ensuring that trains do not run in the affected area at a speed greater than the unplanned speed restriction.
		<b><u>PROCEDURE</u></b>
2703	Signaller	When the need for an <a href="#">unplanned speed restriction</a> is reported, the Signaller must: <ol style="list-style-type: none"> <li>1. Revoke existing movement authorities in or into the area</li> <li>2. Disable automatic route setting into the affected area</li> <li>3. Bring relevant <a href="#">unsupervised movements</a> to a standstill.</li> </ol>
2705	Signaller	The Signaller must ensure that all supervised trains inside or entering the affected area remain at standstill until such time the speed restriction is implemented in the <a href="#">signalling system</a> .
2706	Signaller	If the unplanned speed is lower than the maximum permitted speed for <a href="#">unsupervised movements</a> the Signaller must ensure that all unsupervised movements inside or entering the affected area remain at standstill until the Drivers are informed about the <a href="#">unplanned speed restriction</a> according to the procedure <a href="#">Speed restriction - Inform Driver of an unplanned speed restriction</a> .
3786	Signaller	The Signaller must ensure that the speed restriction is planned according to the procedure <a href="#">Speed restriction - Implementing an unplanned speed restriction</a> .

## Speed restriction

2709			<b>Implementing an unplanned speed restriction</b>
2710	Precondition		The need for an unplanned speed restriction has been reported to the Signaller.
2711	Purpose		Ensuring that the unplanned speed restriction is planned as a temporary speed restriction and activated in the signalling system.
			<b><u>PROCEDURE</u></b>
2712	Signaller		When a need for an <a href="#">unplanned speed restriction</a> is reported, the Signaller must obtain information about the reason for the speed restriction and the location that it must apply.
2713	Signaller		<p>If the speed restriction is reported by staff with relevant technical competences, the Signaller must ensure that the speed restriction is planned in the <a href="#">signalling system</a> according to the reported location and speed. The planning must include the reason for the speed restriction which will be shown on the Driver's DMI as a text message.</p> <p>If the speed restriction is reported by anyone other than staff with relevant technical competences, the Signaller must ensure that the speed restriction is planned with a ceiling speed of 10 km/h, and an additional 200 metres either side of the reported location. The planning must include the reason for the speed restriction which will be shown on the DMI as a text message.</p>
2716	Signaller		<p>When the speed restriction is planned, the Signaller must ensure that it is checked and approved by another person with competences as a Signaller.</p> <p>The Signaller must then finally approve and activate the speed restriction.</p>
2717	Signaller		When the speed restriction is approved by the Signaller, the speed restriction is ready for activation according to the planned starting time.
2718	Signaller		<p>When the speed restriction is activated, and shown on the signalling control display the Signaller ensure entry in the Signaller log and. The entry must include the applicable speed, if possible, the name of the person who requested the activation of the speed restriction, and the location where the speed restriction is applicable.</p> <p>The Signaller must ensure action is taken to restore the infrastructure according to procedure Infrastructure fault - Correcting infrastructure fault.</p>



## Speed restriction

- 3774 **Handling of an unplanned speed restriction in a transition area**
- 3775 **Precondition** The need for an unplanned speed restriction in a transition area has been reported to the Signaller.
- 3776 **Purpose** Ensuring that the speed of the train does not exceed the speed restriction when passing the system border.
- PROCEDURE**
- 3779 **Signaller** When the need for a speed restriction is reported between the "[Start of ETCS-signalling](#)" marker and the first ETCS stop marker, the Signaller must apply the procedure [Speed restriction - Handling an unplanned speed restriction](#) to ensure that no [trains](#) or [vehicles](#) exceed the speed restriction.
- The Signaller must contact the [Legacy signaller](#) responsible for the area on the other side of the transition area and request that the speed restriction is also established in the neighbouring system.
- The Signaller ensure that the speed restriction is planned in the signalling system according to procedure [Speed restriction - Implementing an unplanned speed restriction](#). The Signaller ensure that the speed restriction is planned to start at the "Start of ETCS-signalling" marker and end at least 50 meters after the opposite facing "[Start of ATC-signalling](#)" or "[End of ETCS-signalling](#)" marker.
- 3780 **Signaller** When the need for a speed restriction is reported between the "[Start of ATC-signalling](#)" or "[End of ETCS-signalling](#)" marker and the first main signal, the Signaller must apply the procedure [Speed restriction - Handling an unplanned speed restriction](#) to ensure that no [trains](#) or [vehicles](#) exceed the speed restriction.
- The Signaller must then ensure that the speed restriction is planned in the signalling system according to procedure [Speed restriction - Implementing an unplanned speed restriction](#). The Signaller must ensure that the speed restriction is planned to start 50 metres before the "Start of ATC-signalling" or "End of ETCS-signalling" marker and end at the opposite facing "[Start of ETCS-signalling](#)" marker.
- 3818 **Signaller** Before granting an authority to move past the last ETCS stop marker towards the [system border](#), the Signaller must inform the Driver that the speed restriction in the transition area is also valid past the system border. The information must contain the endpoint of the speed restriction.
- The Signaller may omit informing the Driver when the [Legacy signaller](#) has confirmed that the speed restriction is managed from the system border.

3799 Driver

When the Driver is informed via the DMI, or on an Operational Instruction, about a temporary speed restriction which is valid up to the transitions point, the Driver must assume that the speed restriction is also valid beyond the system border, unless other information is received.



3117			<b>Tunnel</b>
3118			<b>Train triggers alarm from tunnel protection system</b>
3119	Precondition		A train exceeding the tunnel values has passed the tunnel protection system and triggered an alarm.
3120	Purpose		The train is stopped and examined before entering the tunnel to avoid causing any harm to humans, or damage to infrastructure or rolling stock.
			<b><u>PROCEDURE</u></b>
3122	Driver, Signaller		If a supervised <a href="#">train</a> triggers an alarm, the movement authority will be emergency shortened to the location specified in the <a href="#">location specific descriptions</a> .
3123	Signaller		<p>When receiving an alarm from the <a href="#">tunnel protection system</a> the Signaller must:</p> <ul style="list-style-type: none"> <li>- inform the Driver why the <a href="#">train</a> has been stopped</li> <li>- provide the Driver with available useful information concerning the alarm</li> <li>- instruct the Driver where to inspect the train</li> <li>- inform the Network manager.</li> </ul> <p>When the Driver is informed the Signaller may <a href="#">route</a> the train into the inspection track.</p>
3124	Railway Undertaking		The Railway undertaking must have procedures in place for the Drivers describing when the <a href="#">train</a> can resume operation after inspection.
3125	Driver		<p>The Driver must ensure that the <a href="#">train</a> is inspected train in the assigned inspection track. If the Driver cannot inspect the train safely, the Driver may request the Signaller to provide additional protection by applying the procedure Incidents - Signaller protected area requested by staff.</p> <p>After inspection the Driver must inform the Signaller about if and how the train can continue operation.</p>

3514		<b>Incidents</b>
3515		<b>Reporting incident</b>
3516	Precondition	An incident considered being a threat to the safety of people or the operation of the railway is reported or detected.
3517	Purpose	To ensure that the incident is reported and appropriate actions are taken.
		<b><u>PROCEDURE</u></b>
3519	All	When an <b>incident</b> is observed this must be reported to the Signaller immediately. This report has to include the name and contact information of the observer, location of the incident, what the incident is and any other observations or information that may be relevant.
3521	Signaller	If the severity of the reported <b>incident</b> could escalate, the Signaller must attempt to prevent or reduce this by any available means.
3520	Signaller	When the Signaller observes, is involved in or is informed of an <b>incident</b> , the Signaller must ensure that this is reported to the Network manager and the Banedanmark incident investigator immediately.
3522	Signaller	<p>If the <b>incident</b>:</p> <ul style="list-style-type: none"> <li>- was caused by a possible Driver error</li> <li>- has affected the capability of the Driver to safely drive the <b>train</b></li> <li>- was caused by defective <b>rolling stock</b></li> </ul> <p>the Signaller must have permission from the Banedanmark incident investigator prior to allowing the train or <b>vehicle</b> to continue.</p>
3523	Signaller	If the <b>incident</b> was caused by failure in the infrastructure or the infrastructure is damaged, the Signaller must obtain confirmation from the O&M coordinator that the infrastructure is safe to resume operations.
3872	Signaller	<p>If the <b>incident</b> concerns a motorist who passes an activated level crossing, passes right in front of a <b>train</b> or <b>vehicle</b> in an user worked crossing or holds between the barriers in a level crossing, the Signaller must ensure that it is reported to the police .</p> <p>The notification must, as far as possible, contain information about:</p> <ul style="list-style-type: none"> <li>- registration number or the type, brand and color,</li> <li>- possible company name and other special characteristics,</li> <li>- the direction of travel of the car and the distance from the train or vehicle,</li> <li>- the number and location of the level crossing</li> <li>- information about the notifier.</li> </ul>
3873	Signaller	In the event of an <b>incident</b> in connection with a level crossing, the Signaller must immediately ensure that a Maintainer is called in and inform the Banedanmark investigation investigator.

## Incidents

3235			
			<b>Vigilance while driving</b>
3236	Precondition		The Signaller has received information of irregularities that may affect railway safety or operations.
3237	Purpose		Ensure that the Driver of a train or vehicle is informed of irregularities that may affect railway safety or operations, and that other Drivers are informed of the conditions.
			<b><u>PROCEDURE</u></b>
3239	Signaller		<p>If the Signaller is informed of conditions that may affect railway safety or operation, the Signaller may inform the Driver to be vigilant while driving.</p> <p>The Signaller must give clear instructions on the starting and ending points of the area where the Driver must be vigilant, as well as the reason why the Driver must be vigilant.</p> <p>If the Signaller assesses that the speed must be reduced to a speed lower than 40 km/h, the Signaller must use <a href="#">Operational Instruction 5</a> to inform the Driver of the extent of the area where the speed must be reduced, as well as what the applicable speed is.</p> <p>The Signaller must instruct the Driver to report back when the <a href="#">train</a> has passed the area.</p>
3240	Driver		<p>When the Driver is notified to keep be vigilant while driving due to irregularities that may affect railway safety or operation, the Driver must do so.</p> <p>The Driver must adjust the driving based on the Signallers instructions and report back to the Signaller afterwards.</p> <p>The speed while driving with vigilance while driving must not exceed 40 km/h or according to the Signallers instructions in <a href="#">Operational Instruction 5</a>.</p>
3242	Driver		If the Driver observes any danger to other <a href="#">train, vehicles</a> , infrastructure or persons the Driver must immediately apply the procedure <a href="#">Emergency - Handling railway emergency call</a> .

## Incidents

3498		<b>Signaller protected area requested by staff</b>
3499	Precondition	An unplanned need, not related to an emergency, to allow staff short-term access to the track or violation of the safety distance for machinery has occurred.
3500	Purpose	To set up safe conditions to protect the area requested.
		<b><u>PROCEDURE</u></b>
3501	All	<p>The person identifying the need to have an area protected must contact the Signaller and request the protection.</p> <p>The request must include name and mobile phone number (if possible) of the person requesting protection, location, area to be protected and description of situation.</p>
3502	Signaller	<p>When requested to protect an area the Signaller must assess the information to determine the area needed. The Signaller may decide to refuse the request.</p> <p>The Signaller must have in mind that the person requesting the protection may have a limited local knowledge of the area in question.</p>
3503	Signaller	The Signaller must take appropriate measures to safeguard the area requested. This may include making the necessary arrangements with the Shunting area manager.
3504	Signaller	When the area is protected, the Signaller must inform the person requesting the protection about the boundaries of the area.
3795	Signaller	The Signaller must ensure that an entry is made in the Signaller log detailing the <a href="#">signaller protected area</a> .
3505	Signaller	The Signaller must only remove protection after receiving a report from the person who requested the protection, that the need for protection is no longer required.

## Incidents

### 3507 **Signaller protected area requested by Emergency services**

3508 **Precondition** A need, identified by the Emergency services, to allow Emergency services access to the track has occurred.

3509 **Purpose** To set up safe conditions to protect the area requested.

#### **PROCEDURE**

3511 **Signaller** When the Signaller is requested by the Network manager to provide a protected area to allow [Emergency services](#) access to the track, the Signaller must take appropriate measures to safeguard the area requested.

The Signaller must have in mind that it is not persons with knowledge of the railway who are involved when assessing the area to be protected.

3512 **Signaller** When the area is protected the Signaller must inform Network manager about the boundaries of the area.

3796 **Signaller** The Signaller must ensure that an entry is made in the Signaller log detailing the [signaller protected area](#).

3513 **Signaller** The Signaller must only remove protection after receiving a report from the Network manager that the need for protection is no longer required.

2977			<h2>Emergency</h2>
2978			<h3>Impact with object and/or derailment</h3>
2979	Precondition		A train or a vehicle has had an impact with an object and/or a derailment severe enough to cause possible damage or threat to any train, vehicle, infrastructure or people.
2980	Purpose		To prevent the incident from worsening, require relevant help, investigate rolling stock and infrastructure for visible damage and to restore normal operation.
			<b><u>PROCEDURE</u></b>
2981	Driver		When a <a href="#">train</a> or a <a href="#">vehicle</a> has had an impact with an object and/or a derailment the Driver must do an immediate assessment of the severity of the situation. The Driver must establish if the <a href="#">incident</a> presents any danger to other operations in the area.
2982	Driver		If the <a href="#">incident</a> presents a danger to other operations in the area or if the Driver is not able to assess if there is any danger to other operations the Driver must: <ol style="list-style-type: none"> <li>1. <a href="#">Emergency brake</a> the <a href="#">train</a></li> <li>2. Immediately contact the Signaller using the <a href="#">railway emergency call</a> function by applying the procedure <a href="#">Emergency - Handling railway emergency call</a></li> <li>3. Report any immediate danger to other operations in the area.</li> </ol>
2983	Railway Undertaking		The Railway undertaking must have procedures in place to handle the situation where the Driver believes that the <a href="#">train</a> has struck a person.
2984	Driver		If the Driver believes that the <a href="#">train</a> has struck a person the Driver must follow relevant Railway undertaking procedures and report to the Signaller that the train has struck a person.
2986	Signaller		When the Signaller is informed about a situation where a person is believed to have been struck and/or the <a href="#">train</a> may have derailed, or other immediate danger to other operations in the area exists, the Signaller must immediately stop supervised trains in the relevant area. The Signaller must stop all other movements in the relevant area by applying the procedure <a href="#">Emergency - Stop trains and vehicles from entering hazardous area</a> .
3874	Signaller		In case <a href="#">rolling stock</a> is derailed, the Signaller must ensure that operation in the affected area remains suspended until the infrastructure is inspected by the relevant Maintainers.
2988	Driver		When the <a href="#">train</a> involved in the impact is at standstill the Driver must expect the <a href="#">movement authority</a> to be shortened and without exposing people to danger: <ol style="list-style-type: none"> <li>1. Attempt to identify the object involved in the impact</li> <li>2. Re-evaluate danger to other operations in the area</li> <li>3. Report further findings to the Signaller if any and an estimated time frame for investigating possible damages.</li> </ol>

2989	Railway Undertaking		The Railway undertaking must have procedures in place for the Drivers describing when an impact with an object requires assessment from a technical <a href="#">rolling stock</a> specialist before the <a href="#">train</a> can resume operation.
2990	Driver		When the Driver has reported the findings to the Signaller the Driver must try to establish the possible damage the impact has caused on <a href="#">rolling stock</a> and infrastructure without exposing people to danger.
2992	Driver		If there is no visible damage to the infrastructure, and the <a href="#">train</a> can resume normal operation, the Driver must inform the Signaller, and may then request a <a href="#">movement authority</a> .
2993	Driver		If the <a href="#">train</a> can continue with restrictions applied and/or there is visible damage to the infrastructure, the Driver must inform the Signaller about the restrictions and/or the damage. When the Signaller has been informed, the Driver may request a <a href="#">movement authority</a> .
2994	Driver		If the <a href="#">train</a> cannot be moved the Driver must inform the Signaller.
2995	Signaller		If any damage to the infrastructure has been detected or has been reported by the Driver the Signaller must apply the procedure <a href="#">Infrastructure fault - Handling report of infrastructure fault</a> .
2996	Signaller		If the Driver requests a new <a href="#">movement authority</a> with no information on restricted <a href="#">train</a> capabilities, the Signaller may allow a new movement authority for the train.
2997	Signaller		If the Signaller is informed by the Driver that the <a href="#">train</a> has restricted capabilities the Signaller must update the <a href="#">production plan</a> according to the procedure <a href="#">Normal operation - Handling changes to operation</a> .
2998	Signaller		If the Signaller is informed by the Driver that the <a href="#">train</a> is not to be moved the Signaller must apply the procedure <a href="#">Train failure - Assisting a disabled train</a> .
3000	Signaller		If the Signaller needs additional information to assess the situation the Signaller may apply the procedure <a href="#">Incidents - Vigilance while driving</a> .

## Emergency

3003			<b>Stop trains and vehicles from entering hazardous area</b>
3004	Precondition		A train or vehicle is in, about to enter or about to traverse an area identified as hazardous.
3005	Purpose		Reduce the risk of a serious incident by bringing trains and vehicles within or about to enter a hazardous area to a standstill.
			<b><u>PROCEDURE</u></b>
3007	Driver, Signaller		<p>Emergency shortening of a <a href="#">movement authority</a> immediately replaces the movement authority held by the <a href="#">train onboard</a> with the new movement authority:</p> <p>If the train has already passed the new <a href="#">end of authority</a> the train will enter TR-mode. In case the train runs at a speed above the intervention curve of the new movement authority, an automatic brake application will occur.</p>
3008	Signaller		If any supervised <a href="#">trains</a> have <a href="#">movement authorities</a> within, entering or traversing the <a href="#">hazardous area</a> the Signaller must protect supervised trains from entering or moving in the hazardous area by applying an <a href="#">emergency stop</a> or emergency shortening any movement authorities to a location as far as possible preventing the train from entering the hazardous area.
3009	Signaller		The Signaller must ensure that any further setting of <a href="#">routes</a> entering or traversing the <a href="#">hazardous area</a> is prevented.
3010	Signaller		<p>If one unsupervised <a href="#">train</a> or <a href="#">vehicle</a> has <a href="#">authority to move</a> in or into the <a href="#">hazardous area</a> the Signaller must use an emergency call to order the Driver to bring the train or vehicle to a standstill.</p> <p>If more than one unsupervised train or vehicle has authority to move in or into the hazardous area the Signaller must use a group emergency call to order the Drivers to bring the train(s) and/or vehicle(s) to a standstill. Following the group call the Signaller must individually contact each Driver in the group to verify that the train(s) and/or vehicle(s) are at a standstill.</p> <p>If there are railway lines running adjacent to the hazardous area on the Fjernbane infrastructure, the Signaller must ensure that the Signaller or <a href="#">Legacy signaller</a> in charge of the adjacent line is informed that the hazardous area involves their line.</p>
3011	Signaller		<p>If a <a href="#">shunting area</a> is active within the <a href="#">hazardous area</a> the Signaller must contact the Shunting area manager and order that all movements are brought to a standstill.</p> <p>If shunting movements, on <a href="#">routes</a> for shunting, are being performed within the hazardous area, the Signaller must contact the Shunter and order that the movement is brought to a standstill.</p>
3013	Shunting area manager		If ordered by the Signaller to bring all movements to a standstill, the <a href="#">Shunting area</a> manager must immediately inform the Shunter.



3558	Shunter	If the Shunter is ordered by the Signaller or <a href="#">Shunting area</a> manager to bring the shunting movement to a standstill, the Shunter must do so immediately.
3012	Driver	If the Driver is ordered by the Signaller or Shunter to bring the <a href="#">train</a> or <a href="#">vehicle</a> to a standstill the Driver must do so immediately.
3788	Signaller	<p>When all traffic in the <a href="#">hazardous area</a> has been suspended, the Signaller must inform the Network manager.</p> <p>The Signaller must ensure that traffic remains suspended until it is confirmed that it is safe to resume traffic in the area.</p> <p>When the Emergency services has been called, the Signaller must only resume traffic in the area when the Network manager has given permission to do so.</p>

## Emergency

3016		<b>Call Emergency services</b>
3017	Precondition	An incident or other emergency requires Emergency services to be alerted.
3018	Purpose	Alert Emergency services quickly and enable further coordination of the incident.
		<b><u>PROCEDURE</u></b>
3019	Driver	If the Driver requests <b>Emergency services</b> directly, and the <b>train</b> is transporting hazardous goods, the Driver must inform the Emergency services about class, UN-number and position in the train.
3020	Driver	If the Driver has called the <b>Emergency services</b> or if the Driver is aware that the Emergency services have been requested by others relating to an <b>incident</b> on the <b>train</b> or during the journey, the Driver must inform the Signaller.
3021	Signaller	If the Signaller requests <b>Emergency services</b> , for a <b>train</b> transporting hazardous goods, the Signaller must inform the Emergency services about class, UN-number and position in the train.
3022	Signaller	The Signaller must inform the Network manager when aware that <b>Emergency services</b> have been requested in relation to an <b>incident</b> with a <b>train</b> .

## Emergency

3025			<b>Evacuation of train</b>
3026	Precondition		A train must be evacuated.
3027	Purpose		Safe evacuation from a disabled train or a train exposed to any kind of danger as a rescue or precautionary measure.
			<b><u>PROCEDURE</u></b>
3028	Railway Undertaking		The Railway undertaking must have procedures in place describing how and when to conduct an evacuation from all types of <a href="#">rolling stock</a> .
3029	Driver		When the Driver has identified that the <a href="#">train</a> must be evacuated the Driver must inform the Signaller about the exact location of the train and request the Signaller to ensure safe operational conditions for the evacuation.
3032	Signaller		When the Signaller is informed that an evacuation of a <a href="#">train</a> is to be performed, the Signaller must ensure that all other trains or <a href="#">vehicles</a> vacate the area, or are brought to a standstill.  The Signaller must ensure that unsupervised trains and vehicles are not authorised to move in the area.
3033	Signaller		If the Signaller has knowledge of a broken overhead wire in the proximity of the "emergency" <a href="#">train</a> the Signaller must apply the procedure <a href="#">Catenary isolation - Emergency catenary isolation</a> .
3035	Signaller		The Signaller must carry out any relevant procedures included in <a href="#">location specific descriptions</a> before authorising the evacuation of the <a href="#">train</a> .
3037	Signaller		When the area is operationally safe for evacuation the Signaller may authorise the Driver to begin evacuation. The Signaller must inform the Network manager that evacuation has been authorised.
3041	Driver		When the Driver is authorised by the Signaller the Driver must follow Railway Undertaking procedures and procedures in <a href="#">location specific descriptions</a> to ensure safe evacuation of the <a href="#">train</a> .
3042	Driver		When the evacuation is completed and the track is clear of staff and passengers the Driver must inform the Signaller that the evacuation is completed.
3043	Signaller		When the Signaller is informed that the evacuation is completed and the track is clear of staff and passengers the Signaller must inform the Network manager and then allow operations to resume.

## Emergency

3046		<b>Handling railway emergency call</b>
3047	Precondition	A Driver is involved in or observes an incident or other emergency situation. A Driver has made a railway emergency call.
3048	Purpose	Alert the Signaller and other affected Drivers in the area and ensure that appropriate actions are taken.
		<b><u>PROCEDURE</u></b>
3052	Signaller	When receiving a <a href="#">railway emergency call</a> the Signaller must evaluate the report from the Driver and determine if the <a href="#">incident</a> may be hazardous to other <a href="#">trains</a> in the area.  The Signaller must apply the procedure <a href="#">Emergency - Stop trains and vehicles from entering hazardous area</a> if the area is determined to be hazardous to other trains.
3053	Signaller	The Signaller must alert the appropriate <a href="#">Emergency services</a> in response to the reported <a href="#">emergency situation</a> , as necessary.
3054	Signaller	The Signaller must provide the details about the emergency to the Network manager.
3055	Signaller	The Signaller must inform other parties about the emergency if required in <a href="#">location specific descriptions</a> and follow any included special procedures.
3801	Signaller	The Signaller must inform <a href="#">trains</a> driving <a href="#">on sight</a> because of the <a href="#">railway emergency call</a> , when driving on sight is no longer required.

## Emergency

2846			<b>Emergency brake activated by person</b>
2847	Precondition		Emergency brake is activated by a passenger or train crew member.
2848	Purpose		To examine the reason for the activation and how to proceed if possible.
			<b><u>PROCEDURE</u></b>
3089	Driver		<p>If a <a href="#">train</a> is braked without the Driver applying the brake, the Driver must:</p> <ul style="list-style-type: none"> <li>- inform the Signaller</li> <li>- provide an estimate for the time needed for examination</li> <li>- examine the reason for the brake application.</li> </ul> <p>The Driver must expect any <a href="#">movement authority</a> to be shortened immediately.</p>
2850	Railway Undertaking		The Railway Undertaking must have procedures for handling an <a href="#">emergency brake</a> activation inside a non-stopping area. This must include enabling the Driver to override the emergency brake application when within a non-stopping area. The <a href="#">route book</a> will indicate the location of non-stopping areas.
2851	Driver		If the <a href="#">train</a> is inside a non-stopping area, the Driver must override the <a href="#">emergency brake</a> activation and react according to the <a href="#">location specific description</a> .
2854	Signaller		When the Signaller is informed of an unplanned standstill the Signaller must mark the <a href="#">train</a> with the <a href="#">failed train marking</a> , and use the information on an expected timeframe for fault investigation to update routing of trains to minimise impact to the <a href="#">production plan</a> .
2855	Driver		<p>If the situation can be resolved with no restrictions, the Driver must inform the Signaller. When the Signaller has been informed, the Driver may request a <a href="#">movement authority</a>.</p> <p>If the situation can be resolved but requires restrictions, the Driver must inform the Signaller about the restrictions. When the Signaller has been informed, the Driver may request a movement authority.</p> <p>If the situation requires the <a href="#">train</a> to be kept at a standstill, the Driver must contact the Signaller.</p>
2856	Signaller		If the Driver requests a new <a href="#">movement authority</a> with no information on restricted <a href="#">train</a> capabilities the Signaller must remove the marking of "failed train" to allow a new movement authority for the train.
2857	Signaller		<p>If the Signaller is informed by the Driver that the <a href="#">train</a> has restricted capabilities the Signaller must:</p> <ol style="list-style-type: none"> <li>1. Update the <a href="#">production plan</a> according to the procedure <a href="#">Normal operation - Handling changes to operation</a></li> <li>2. Remove the <a href="#">failed train marking</a> to allow a new <a href="#">movement authority</a> for the train.</li> </ol>

2858 Signaller

If the Signaller is informed by the Driver that the [train](#) is not to be moved the Signaller must initiate the procedure [Train failure - Assisting a disabled train](#).

## Emergency

3058		<b>Bridge collision alarm</b>	
3059	Precondition		A potential collision with a railway bridge has been reported by a competent person or detected by a collision detection system.
3060	Purpose		To avoid any trains or vehicles being trapped on the bridge when a potential collision has been identified.
		<b><u>PROCEDURE</u></b>	
3062	Signaller		The "Bridge collision" function will stop all trains approaching the bridge and let trains already on the bridge continue.
3063	Signaller		<p>When the Signaller receives a bridge collision alarm the Signaller must:</p> <ol style="list-style-type: none"> <li>1. Use the "Bridge collision" function to prevent supervised trains from approaching the bridge.</li> <li>2. Contact any Drivers stopped on the bridge to make immediate arrangements for their trains or <a href="#">vehicles</a> to be moved to a safe location.</li> <li>3. Follow the location specific instructions for moving trains running on <a href="#">Operational Instructions</a>.</li> <li>4. Contact any Shunter or PICOP with authority on the bridge.</li> </ol>
3064	Signaller		The Signaller must inform the Network manager that further traffic crossing the bridge is suspended due to a potential bridge collision.
3065	Signaller		The Signaller may only resume traffic after receiving authorisation from the person responsible for the specific bridge.

## Emergency

3319			<b>Emergency situation on a bascule bridge</b>
3320	Precondition		A potentially hazardous situation on a bascule bridge is identified by the Bridge guard.
3321	Purpose		To avoid any trains or vehicles entering the bridge when a potential hazardous situation has been identified.
			<b><u>PROCEDURE</u></b>
3322	Signaller, Bridge guard		An <a href="#">emergency stop</a> button is available to the bridge guard. Pressing the emergency stop button will emergency stop all trains with a movement authority on, or on to, the bridge.
3323	Bridge guard		<p>When the Bridge guard identifies a potentially hazardous situation is emerging on the bridge, the Bridge guard must assess if the optimal solution is to stop the train immediately, or allow the train to pass the bridge before stopping operations.</p> <p>If the Bridge guard assesses that the train has to be stopped immediately, the Bridge guard must press the <a href="#">emergency stop</a> button, and immediately inform the Signaller about the situation.</p> <p>If the Bridge guard assesses that the train has to pass the bridge before stopping operations, the Bridge guard must immediately inform the Signaller about the situation. The Bridge guard must press the emergency stop button as soon as the train has passed.</p>
3324	Signaller		<p>If the Signaller is informed by the Bridge guard of a potential hazardous situation on the bridge, the Signaller must:</p> <ol style="list-style-type: none"> <li>1. Apply the procedure <a href="#">Emergency - Stop trains and vehicles from entering hazardous area</a></li> <li>2. Contact any PICOP with authority on the bridge.</li> </ol>
3325	Signaller		The Signaller must inform the Network manager that further traffic crossing the <a href="#">bascule bridge</a> is suspended due to a potentially hazardous situation.
3326	Bridge guard		The Bridge guard must inform the Signaller when the potentially hazardous situation is resolved and the bridge has not been damaged.
3327	Signaller		<p>If the potential hazardous situation is resolved and the bridge has not been damaged, the Signaller may resume traffic when confirmation from the Bridge guard is received. The Signaller must inform the Network manager that traffic has resumed.</p> <p>If the bridge has been damaged the Signaller may only resume traffic after receiving authorisation from the person responsible for the bridge.</p>



2384		<b>Infrastructure fault</b>
2385		<b>Handling report of infrastructure fault</b>
2386	Precondition	A fault or error in the infrastructure is detected by an observer or the signalling system.
2387	Purpose	To quickly process faults or error and identify the problem to avoid further damages and/or accidents.
		<b><u>PROCEDURE</u></b>
2388	O&M coordinator	When a fault report is received the O&M coordinator must ensure the fault or error is logged in the <a href="#">signalling system</a> . The O&M coordinator must in coordination with the Signaller decide upon the most appropriate response to the reported fault or error.
2390	Signaller	If the Signaller assess the situation as hazardous, the Signaller must use all possible means to stop all movements from entering the <a href="#">hazardous area</a> by initiating the procedure <a href="#">Emergency - Stop trains and vehicles from entering hazardous area</a> .
2389	Signaller	If a fault report is received from sources other than the O&M coordinator the Signaller must inform and discuss the implications with the O&M coordinator.  If the reported fault concerns the catenary system, the Signaller must inform the Catenary manager.
2391	O&M coordinator	If the fault or error demands an <a href="#">unplanned speed restriction</a> the O&M coordinator must ensure the procedure <a href="#">Speed restriction - Implementing an unplanned speed restriction</a> is initiated.
2392	O&M coordinator	If the fault or error results in changes to driving conditions the O&M coordinator must initiate the procedure <a href="#">Infrastructure fault - Changes in driving conditions</a> .
2393	O&M coordinator	The O&M coordinator must contact the maintainer to plan appropriate corrective actions.

## Infrastructure fault

2397		<b>Correcting infrastructure fault</b>
2398	Precondition	The O&M coordinator has called in a Maintainer for corrective maintenance. The Maintainer has arrived at the site of the reported fault and is ready to commence fault correction.
2399	Purpose	Correct faults without affecting the safety of trains.
		<b><u>PROCEDURE</u></b>
2403	Maintainer	<p>The Maintainer must assess if <a href="#">corrective maintenance</a> can be done without affecting traffic or safety.</p> <p>If the corrective maintenance can be performed without affecting traffic or safety, the Maintainer may commence correcting the fault.</p> <p>If the corrective maintenance will affect traffic or safety, the Maintainer must contact the Signaller to obtain authorisation and arrange the course of work.</p>
2404	Signaller	<p>If the Signaller is informed by a Maintainer that <a href="#">corrective maintenance</a> will affect traffic or safety, the Signaller must take necessary actions to ensure the safety of <a href="#">train</a> operations will not be affected.</p> <p>The Signaller must consider arranging for the corrective maintenance activity to be performed at a different time, if performing the activity will cause significant disruption to rail traffic. The Signaller must coordinate the activity in cooperation with the O&amp;M coordinator. The Signaller may consider diverting rail traffic to permit the maintenance activity to be undertaken safely.</p> <p>The Signaller must record any restrictions to full operational use of the infrastructure in the <a href="#">Signaller log</a>.</p> <p>When the Signaller has ensured that the work can be performed without affecting the safety of train operations, the Signaller may authorise the Maintainer to commence corrective maintenance.</p>
2405	Maintainer	When the <a href="#">corrective maintenance</a> is complete, the Maintainer must report to the O&M coordinator and the Signaller that work is complete and include any unresolved issues.
2406	O&M coordinator	The O&M coordinator must handle any reports of unresolved issues by applying the procedure <a href="#">Infrastructure fault - Handling report of infrastructure fault</a> .
2407	Signaller	When informed by the Maintainer that the work is complete, the Signaller may revoke related restrictions in the <a href="#">signalling system</a> . The Signaller must update the records in the <a href="#">Signaller log</a> , including details of restrictions that have been revoked.

## Infrastructure fault

2410			<b>Reset of axle counter section</b>
2411	Precondition		The signalling system unexpectedly indicates an axle counter section as occupied or disturbed.
2412	Purpose		Reset of the axle counter section.
			<b><u>PROCEDURE</u></b>
2413	Signaller		If the <a href="#">signalling system</a> detects that an <a href="#">axle counter</a> section is unexpectedly occupied, the signalling system will indicate the fault to the Signaller on the <a href="#">signalling control display</a> .
2414	Signaller		When the <a href="#">signalling system</a> indicates that an <a href="#">axle counter</a> section is unexpectedly occupied, the Signaller must assess if the occupancy could be caused by <a href="#">rolling stock</a> in the track.
2416	Signaller		When the Signaller has assessed the cause of the unexpected occupancy, and the track is, or is presumed to be, unoccupied, the Signaller must ensure that no other trains are authorised into the track section.  The Signaller may then reset the <a href="#">axle counter</a> .
3585	Signaller		When the <a href="#">axle counter</a> section is reset, the Signaller must instruct the Driver of the first train to pass over the axle counter section to be vigilant to obstructions and any possible conflicting movements for the route ahead including, as far as practicable, conflicting movements from the flank.  The Signaller must instruct the Driver to report back when the movement is completed.

## Infrastructure fault

- 3924 **Reset of axle counter section in a possession**
- 3925 **Precondition** The signalling system indicates occupied or disturbed in connection with infrastructure work. The axle counter section is unoccupied.
- 3926 **Purpose** Reset of axle counter section in a possession.
- PROCEDURE**
- 3928 When a PICOP is aware that an axle counter section needs to be reset inside a possession, the PICOP must ensure that no **shunting movements** are permitted to move in, or into, the axle counter section that needs to be reset.
- 3929 Once the PICOP has ensured that no **shunting movements** are permitted to move in, or into, the axle counter section, the PICOP must ensure that the axle counter section to be reset is unoccupied.
- The PICOP may then request the Signaller to reset the axle counter.
- 3930 When the axle counter section is reset, the PICOP shall instruct the Shunter of the first **train** or **vehicle** to pass through the axle counter section to be aware of obstacles and possible movements in conflict with the **shunting movement**, including, as far as possible, any conflicting movements from the flank.
- The PICOP shall instruct the Shunter to report back when the shunting movement has been completed.
- 3931 When the **shunting movement** has been completed and the PICOP has received a message from the Shunter that the axle counter section has been traversed, the PICOP must report this to the Signaller.

## Infrastructure fault

2748		<b>Handling of a trailed point</b>
2749	Precondition	The Signaller needs to issue an Operational Instruction 1 passing a trailed point. The point has been examined by a technician and the point is clamped in the required lie. Any operational constraints have been logged in the Signaller log.
2750	Purpose	Setup conditions to allow the Signaller to authorise the Driver to pass a trailed point.
		<b><u>PROCEDURE</u></b>
2751	Signaller	The Signaller must assess if there are any constraints preventing the passing of the point by checking the <a href="#">Signaller log</a> .
2752	Signaller	If any constraint in the <a href="#">Signaller log</a> prevents the passing of the point, the Signaller must inform the Driver.

## Infrastructure fault

2762			<h3>Handling of an undetected point that is not trailed</h3>
2763	Precondition		The Signaller needs to issue an Operational Instruction 1. A train is at a standstill and ready to pass a point in a situation where a point is not detected. The missing detection is not caused by trailing.
2764	Purpose		Ensure safe passing of point without detection. The missing detection is not caused by trailing.
			<h4><u>PROCEDURE</u></h4>
2765	Signaller		The Signaller must assess if the point is going to be passed in a trailing or a <a href="#">facing direction</a> .
2766	Signaller		<p>If the point is going to be passed in a <a href="#">trailing direction</a> the Signaller must ensure the point is in the <a href="#">correct lie</a>, e.g. by assessment from the Driver. When the point is confirmed to be in the correct lie, the Signaller must block the point.</p> <p>When the point is in the correct lie, and the point is blocked, the Signaller may consider the point as safe to pass.</p>
2767	Signaller		<p>If the point is going to be passed in a <a href="#">facing direction</a> the Signaller must ensure the point is in the <a href="#">correct lie</a>, e.g. by assessment from the Driver.</p> <p>When the facing point is in the correct lie, the Signaller must ensure the point is clamped.</p> <p>The Signaller may request the Driver to <a href="#">clamp</a> the point. When the facing point is clamped the Signaller must ensure the information is recorded in the <a href="#">Signaller log</a>.</p>
3087	Signaller		When the point is clamped the Signaller may consider the point as safe to pass.
2770	Railway Undertaking		The Railway Undertaking must provide instructions to enable the Driver to <a href="#">clamp</a> a point based on instructions provided by Banedanmark.
2771	Driver		<p>After request from the Signaller, the Driver must at any time be prepared to <a href="#">clamp</a> a point.</p> <p>The Driver may request the Signaller to provide additional protection in order to carry out clamping of the point by initiating procedure <a href="#">Incidents - Signaller protected area requested by staff</a>.</p>

## Infrastructure fault

3177		<b>Changes in driving conditions</b>
3178	Precondition	A Maintainer has inspected an infrastructure fault and has identified a change in the condition of the infrastructure. This is reported to the O&M coordinator.
3179	Purpose	To update the condition of the infrastructure in the signalling system and adjust operations to the new capabilities.
		<b><u>PROCEDURE</u></b>
3180	O&M coordinator	If the O&M coordinator is informed about a change in the condition of the infrastructure, the O&M coordinator must evaluate the consequences of the change. The O&M coordinator must do so in close cooperation with the Signaller.
3181	Signaller	<p>If the Signaller is informed about a change in the condition of the infrastructure, the Signaller must evaluate the consequences of the change and the necessary changes to operations. The Signaller must do so in close cooperation with the O&amp;M coordinator.</p> <p>The Signaller must inform the Dispatcher about the changes in driving conditions.</p>
3182	O&M coordinator	The O&M coordinator must initiate appropriate measures and register the changes in conditions in the infrastructure in the <a href="#">signalling system</a> .

2171			<b>Possession</b>
2172			<b>Plan possession for corrective maintenance</b>
2173	Precondition		Corrective maintenance has been agreed with the O&M coordinator and a need for a possession has been identified.
2174	Purpose		Planning of possession for corrective maintenance and issuing of possession documentation.
			<b><u>PROCEDURE</u></b>
2175	PICOP		The PICOP must contact the Signaller and request a <a href="#">possession</a> for <a href="#">corrective maintenance</a> . The request must contain a specification of: <ul style="list-style-type: none"> <li>- location</li> <li>- the <a href="#">ETCS stop markers</a> and buffer stops marking the boundaries of the requested possession</li> <li>- an estimate of the time required for the work.</li> </ul>
2176	Signaller		The Signaller must ensure that the <a href="#">possession</a> , including <a href="#">protection requirements</a> , is planned in the <a href="#">signalling system</a> to meet the request of the PICOP. <p>The Signaller must ensure that the planning of the possession is checked and approved by another person with competences as a Signaller.</p>
2177	Signaller		When the planning of the <a href="#">possession</a> is checked and approved, the <a href="#">signalling system</a> will generate a unique possession ID.
2178	Signaller		If the <a href="#">possession</a> can be planned according to the PICOP's request, the Signaller must inform the PICOP about the possession ID and the timing of the possession.
2179	Signaller		If the <a href="#">possession</a> cannot be planned according to the request, the Signaller must reject the request and inform the PICOP.



## Possession

### 2182 Request planned possession with handheld terminal

2183 Precondition The PICOP has arrived at the site and is ready to initiate a planned possession.

2184 Purpose Indicating that the PICOP is ready at the site, and determining if the possession can be established as planned.

### PROCEDURE

2185 PICOP The PICOP must use the [handheld terminal](#) to request the [planned possession](#).





2186 Signaller , PICOP  The [signalling system](#) can only activate a [possession](#) if all elements of the area are not locked by a route, or by an overlap, or reserved by another established temporary shunting area or possession.

3722 Signaller When the [signalling system](#) requests to establish a [possession](#), the Signaller must assess if there are any conditions preventing the possession from being established as planned.

If the possession can be established as planned, the Signaller must accept the request from the signalling system.

If the possession cannot be established as planned, the Signaller must reject the request from the signalling system and contact the PICOP.

## Possession

2192			<b>Establish possession with handheld terminal</b>
2193	Precondition		The PICOP is at the possession site and has requested a planned possession using the handheld terminal. The possession request has been assessed and accepted by the Signaller.
2194	Purpose		Establish a planned possession.
			<b><u>PROCEDURE</u></b>
2195	Signaller		When the Signaller has accepted the <a href="#">possession</a> request, the <a href="#">signalling system</a> will commence the <a href="#">protection requirements</a> and present the possession to the Signaller on the <a href="#">signalling control display</a> and request the Signaller to confirm. The possession protection requirements are implemented once the Signaller has confirmed the possession.
2196	Signaller		<p>When the Signaller is presented with the <a href="#">possession</a> on the <a href="#">signalling control display</a>, the Signaller must check that the possession data indicated on the signalling control display is consistent with the possession planning.</p> <p>If the possession data indicated on the signalling control display is consistent with the possession planning, the Signaller must confirm that the <a href="#">protection requirements</a> can be implemented.</p>
3725	Signaller		If the <a href="#">possession</a> data indicated on the <a href="#">signalling control display</a> is <b>NOT</b> consistent with the possession planning, the Signaller must reject the possession and as far as possible ensure that a new possession is planned in cooperation with the PICOP.
2198	Signaller , PICOP		Once the Signaller has confirmed the <a href="#">possession</a> and the <a href="#">protection requirements</a> are implemented, the <a href="#">signalling system</a> will request the PICOP to prove their location according to possession data. The possession cannot be established until the PICOPs location has been proven correctly.
2199	PICOP		When requested by the <a href="#">signalling system</a> , the PICOP must prove their location by scanning an RFID-tag (Radio-frequency identification) at an <a href="#">ETCS stop marker</a> , or other infrastructure object associated with the <a href="#">possession</a> .
2200	Signaller , PICOP		Scanning an ID-tag not associated with the <a href="#">possession</a> will result in the PICOP receiving an error message on the <a href="#">handheld terminal</a> .
2201	PICOP		If the PICOP cannot prove their location correctly, the PICOP must inform the Signaller.
2202	Signaller , PICOP		When the location of the PICOP is proven correctly, the <a href="#">signalling system</a> will establish the <a href="#">possession</a> and send a message to the <a href="#">handheld terminal</a> confirming to the PICOP that the possession is established.
3789	Signaller		The Signaller must ensure that the establishing time and <a href="#">possession</a> data is recorded in the <a href="#">Signaller log</a> .

2203 PICOP

When the handheld terminal indicates that the possession is established, the PICOP must note the time in the PICOP log. The PICOP must then setup worksite protection.

## Possession



2206			<h3>Establish possession without handheld terminal</h3>
2207	Precondition		<p>The PICOP has arrived at the site and is ready to initiate a planned possession. It is not technically possible to use a handheld terminal.</p> <p>The establishment of the possession without a handheld terminal has been agreed with the Person responsible for traffic operation.</p>
2208	Purpose		<p>Indicating that the PICOP is ready at the site and, if possible, establishing the possession as planned.</p>
			<h3><u>PROCEDURE</u></h3>
2209	PICOP		<p>When the PICOP is ready to initiate the <a href="#">planned possession</a> in an interlocked area, the PICOP must contact the Signaller to request the planned possession. The request must contain:</p> <ul style="list-style-type: none"> <li>- <a href="#">possession</a> ID</li> <li>- <a href="#">PICOP ID</a></li> <li>- PICOP mobile phone number</li> <li>- location in the infrastructure.</li> </ul>
3875	PICOP		<p>If the <a href="#">possession</a> is outside the interlocked area and a Shunting area manager is present on site, the PICOP must arrange the possession with the Shunting area manager.</p> <p>Before a possession is established outside an interlocked area the PICOP must inform the Signaller.</p>
2210	Signaller		<p>When the Signaller is contacted by a PICOP requesting a <a href="#">planned possession</a>, the Signaller must assess if there are any conditions preventing the <a href="#">possession</a> from being established as planned.</p> <p>If the possession can be established as planned, the Signaller must manually request the possession in the <a href="#">signalling system</a>.</p> <p>If the possession cannot be established as planned, the Signaller must contact the PICOP and inform about the reason for the rejection.</p>
2211	Signaller		<p>The <a href="#">signalling system</a> can only activate a <a href="#">possession</a> if all elements of the area are not locked by a route, or by an overlap, or reserved by another established temporary shunting area or possession.</p>
3726	Signaller		<p>When the Signaller is presented with the <a href="#">possession</a> on the <a href="#">signalling control display</a>, the Signaller must check that the possession data indicated on the signalling control display is consistent with the possession planning.</p> <p>If the possession data indicated on the signalling control display is consistent with the possession planning, the Signaller must confirm that the <a href="#">protection requirements</a> can be implemented.</p>
3727	Signaller		<p>If the <a href="#">possession</a> data indicated on the <a href="#">signalling control display</a> is <b>NOT</b> consistent with the possession planning, the Signaller must reject the possession and as far as possible ensure that a new possession is planned in cooperation with the PICOP.</p>

3724	Signaller		The <a href="#">possession</a> is established when the Signaller has approved it.
3790	Signaller		The Signaller must ensure that the establishing time and <a href="#">possession</a> data is recorded in the <a href="#">Signaller log</a> .
2212	Signaller		When the <a href="#">possession</a> is approved, the Signaller must request the PICOP to prove their location.
3838	PICOP		After request from the Signaller, the PICOP must prove their location in the infrastructure by reading the ID-number on the plate of an ETCS stop marker associated with the <a href="#">possession</a> .
3839	Signaller		When the PICOP has proven their location correctly, the Signaller must inform the PICOP that the <a href="#">possession</a> is established (including establishing time) and inform about the boundaries of the possession and planned end time.
2213	PICOP		When instructed by the Signaller that the <a href="#">possession</a> is established, the PICOP must register the name of the Signaller as well as time and date of establishing the possession in the PICOP log. The PICOP must then setup <a href="#">worksite protection</a> .

## Possession

3747		<b>Establish possession in a transition area</b>
3748	Precondition	The PICOP is ready to establish possessions on both sides of the system border in the transition area.
3749	Purpose	Establishing of possessions in the transition area and ensuring that all relevant agreements are made with the Signallers on both sides of the system border.
<b><u>PROCEDURE</u></b>		
3752	PICOP	The PICOP must apply the procedure <a href="#">Possession - Request planned possession with handheld terminal</a> or <a href="#">Possession - Establish possession without handheld terminal</a> to establish the possession in the <a href="#">level 2</a> area.
3753	Signaller	When receiving a request to establish a possession in a <a href="#">transition area</a> , the Signaller must first contact the <a href="#">Legacy signaller</a> and request that signalling to the transition area is prevented.  The Signaller may then apply the procedure <a href="#">Possession - Request planned possession with handheld terminal</a> or <a href="#">Possession - Establish possession without handheld terminal</a> .
3754	PICOP	Only when possessions on both sides of the <a href="#">system border</a> are established and the worksite protection is placed the PICOP may authorise the work to commence.

## Possession



2229			<b>Possession handover with handheld terminal</b>
2230	Precondition		A relieving PICOP is ready to take over responsibility of an active possession. Both the responsible PICOP and the relieving PICOP have handheld terminals available.
2231	Purpose		Handing over responsibility of a possession between two PICOPs, and ensuring data is transferred to the signalling system.
			<b><u>PROCEDURE</u></b>
2233	PICOP		Before responsibility of a <a href="#">possession</a> can be handed over, the relieving PICOP must obtain all relevant information about the possession from the responsible PICOP.
2234	PICOP		Using the <a href="#">handheld terminal</a> , the relieving PICOP must select the unique <a href="#">possession ID number</a> and request <a href="#">possession</a> handover.
2235	PICOP		The <a href="#">handheld terminal</a> allows the relieving PICOP to request a <a href="#">possession</a> handover. The handheld terminal of the responsible PICOP will indicate the request and require an acknowledgement.
2236	PICOP		When presented with a <a href="#">possession</a> handover request, the responsible PICOP must decide if it is appropriate and convenient for the handover to take place. Using the <a href="#">handheld terminal</a> the PICOP must either accept or reject the request.
2237	PICOP		If the responsible PICOP accepts the <a href="#">possession</a> handover request, the <a href="#">signalling system</a> automatically updates the possession data in the <a href="#">Signaller log</a> and sends out a message to both PICOPs confirming the change in responsibility.  If the responsible PICOP rejects the possession handover, a rejection message is sent to the <a href="#">handheld terminal</a> of the relieving PICOP.
2238	PICOP		Once the relieving PICOP receives a confirmation message on the <a href="#">handheld terminal</a> , responsibility for the <a href="#">possession</a> is transferred and the relieving PICOP becomes the PICOP responsible for the possession. The PICOP must note the time in the PICOP log.
2239	PICOP		If the relieving PICOP receives a rejection on the handover request the relieving PICOP must contact the responsible PICOP to negotiate conditions for handover.

## Possession

2243		<b>Possession handover without handheld terminal</b>
2244	Precondition	A relieving PICOP is ready to take over responsibility of an active possession. Either of the PICOPs, or both, are without a handheld terminal.
2245	Purpose	Handing over responsibility of a possession between two PICOPs, and ensuring data is transferred to the signalling system.
		<b><u>PROCEDURE</u></b>
2246	PICOP	Before responsibility of a <a href="#">possession</a> can be handed over, the relieving PICOP must obtain all relevant information about the possession from the responsible PICOP.
2247	PICOP	The relieving PICOP must contact the Signaller and request the <a href="#">possession</a> handover. If the possession is outside interlocked areas and a Shunting area manager is assigned to the area, the PICOP informs the Shunting area manager.  The request must contain:  <ul style="list-style-type: none"> <li>- possession ID</li> <li>- relieving <a href="#">PICOP ID</a></li> <li>- relieving PICOP mobile phone number.</li> </ul>
2248	Signaller	When the PICOP contacts the Signaller to request a <a href="#">possession</a> handover, the Signaller must update the possession data in the <a href="#">Signaller log</a> and in the <a href="#">signalling system</a> .
2250	Signaller	When the <a href="#">possession</a> data in the <a href="#">Signaller log</a> and the <a href="#">signalling system</a> is updated, the Signaller must inform the relieving PICOP about the time when responsibility for the possession is handed over.
2251	PICOP	The relieving PICOP assumes responsibility of the <a href="#">possession</a> when the Signaller has confirmed that details have been recorded. The relieving PICOP must then contact the PICOP to confirm the transfer in responsibility.  Both PICOP's must register the date and time of possession handover in their PICOP logs.
3797	PICOP	Where the PICOP has a <a href="#">handheld terminal</a> available, the PICOP must use it to request the control of the <a href="#">possession</a> be transferred from the <a href="#">signalling system</a> to the handheld terminal.



## Possession

2254			<b>End possession with handheld terminal</b>
2255	Precondition		Infrastructure work has been completed and information about any restrictions in the use of the infrastructure is passed on to the Signaller. The PICOP has a handheld terminal available.
2256	Purpose		Ensure that the responsibility of the infrastructure is handed back to the Signaller.
			<b><u>PROCEDURE</u></b>
2259	PICOP		When the PICOP has determined that the infrastructure is safe to be handed back into operations, according to the rules for working in infrastructure, the PICOP must remove the <a href="#">worksite protection</a> .
2261	PICOP		The PICOP must end a <a href="#">possession</a> by selecting the appropriate possession ID on the <a href="#">handheld terminal</a> and scan an RFID-tag (Radio-frequency identification) at an <a href="#">ETCS stop marker</a> , or other infrastructure object associated with the possession.
2262	PICOP		Scanning a tag not associated with the <a href="#">possession</a> will result in an error message.
2263	Signaller , PICOP		When a request to end a <a href="#">possession</a> is received from the <a href="#">handheld terminal</a> , the <a href="#">signalling system</a> will run a diagnostics test of the infrastructure and log any detected errors.  The signalling system will present any detected errors to the Signaller on the signalling control display and request the Signaller to accept or reject to end the possession.  If the request to end the possession is accepted it will be indicated on the handheld terminal.
2265	Signaller		When a request to end a <a href="#">possession</a> is displayed on the signalling control display, the Signaller must decide if the possession can be ended as requested. The Signaller must either accept or reject the request.
2264	PICOP		When the <a href="#">handheld terminal</a> indicates that the request to end the <a href="#">possession</a> has been accepted the PICOP is relieved of responsibility for the infrastructure. The PICOP must note the time in the PICOP log.
3791	Signaller		The Signaller must ensure that the time the <a href="#">possession</a> was ended is recorded in the <a href="#">Signaller log</a> .
2266	PICOP		If an end of <a href="#">possession</a> request is rejected due to detected infrastructure errors the PICOP must contact the Signaller to negotiate conditions for ending the possession.

## Possession

2269

### End possession without handheld terminal

2270 Precondition

Infrastructure work has been completed and information about any restrictions in the use of the infrastructure is passed on to the Signaller. It is not technically possible to use a handheld terminal.

The ending of the possession without a handheld terminal has been agreed with the Person responsible for traffic operation.

2271 Purpose

Ensure that the responsibility of the infrastructure is handed back to the Signaller.

### PROCEDURE

2274 PICOP

When the PICOP has determined that the infrastructure is safe to be handed back into operations, according to the rules for working in infrastructure, the PICOP must remove the [worksite protection](#).

3890 PICOP

If the [possession](#) is outside interlocked areas and a Shunting area manager is assigned to the area, the PICOP informs the Shunting area manager.

If the possession is outside interlocked areas the PICOP informs the Signaller.

2276 PICOP

The PICOP must end a [possession](#) or a part of a possession inside interlocked areas by contacting the Signaller and report:

- [PICOP ID](#)
- possession ID of the possession that can be ended
- that the area is safe for operations.

2277 Signaller

When the Signaller receives a request to end a [possession](#) from a PICOP the Signaller must:

1. Verify that the PICOP is registered as responsible for the possession
2. enter the request into the [signalling system](#).

2278 PICOP, Signaller



The [signalling system](#) will run a diagnostics test of the infrastructure handed back by the Signaller and log any detected errors. If any error is detected the signalling system will request the Signaller for an acknowledgement.

If no error is detected the request to end a [possession](#) is automatically accepted.

2279 Signaller

The Signaller must evaluate reported errors indicated on the signalling control display and either reject or accept the request to end a [possession](#).

2280 Signaller

If the request to end the [possession](#) is rejected due to detected infrastructure errors the Signaller must instruct the PICOP to correct the error or negotiate conditions for ending the possession.

2281 Signaller

When the [possession](#) is ended, the Signaller must inform the PICOP the time it was ended.

2282	PICOP	When the PICOP is informed by the Signaller of the time the <u>possession</u> ended the PICOP must enter the time into the PICOP log and then the PICOP is relieved of responsibility for the infrastructure.
3792	Signaller	The Signaller must ensure that the time the <u>possession</u> was ended is recorded in the <u>Signaller log</u> .

## Possession

3760		<b>End possession in a transition area</b>
3761	Precondition	The infrastructure work has finished and the PICOP is ready to end both possessions in a transition area.
3762	Purpose	Ensure that the responsibility for the infrastructure on both sides of the system border is handed back to operation.
		<b><u>PROCEDURE</u></b>
3765	PICOP	<p>Before a <a href="#">possession</a> in a <a href="#">transition area</a> can be ended, the PICOP must ensure that both possessions are ready to be ended.</p> <p>The PICOP may then apply the procedure <a href="#">Possession - End possession with handheld terminal</a> or <a href="#">Possession - End possession without handheld terminal</a> to end the possession in the level 2 area.</p>
3766	Signaller	When the PICOP requests to end a <a href="#">possession</a> in a <a href="#">transition area</a> , the Signaller must apply the procedure <a href="#">Possession - End possession with handheld terminal</a> or <a href="#">Possession - End possession without handheld terminal</a> .
3767	PICOP	When both <a href="#">possessions</a> in the <a href="#">transition area</a> are ended, the PICOP must report to the Signaller or <a href="#">Legacy signaller</a> responsible for the part of the infrastructure where the possession was ended last, that both possessions are ended, and the track is cleared.
3768	Signaller	When the PICOP reports that both <a href="#">possessions</a> in the <a href="#">transition area</a> are ended, the Signaller must contact the <a href="#">Legacy signaller</a> and agree the conditions for resuming operation.

2318			<h2>Catenary isolation</h2>
2319			<h3>Establish planned catenary isolation</h3>
2320	Precondition		The Catenary manager is ready to establish a planned catenary isolation.
2321	Purpose		Assess if the planned catenary isolation can be performed as planned without affecting safety or operations.
			<b><u>PROCEDURE</u></b>
3856	Catenary manager		The Catenary manager must contact the Signaller and request permission to establish a <a href="#">planned catenary isolation</a> . The request must include a specification of the <a href="#">catenary isolation</a> ID, location and an identification of catenary sections where the power will be isolated.
3857	Signaller		When the Signaller is requested by the Catenary manager to authorise a <a href="#">planned Catenary isolation</a> , the Signaller must assess if there are any conditions which prevents the <a href="#">catenary isolation</a> from being established as planned.
3858	Signaller		If there are any conditions which prevents the <a href="#">catenary isolation</a> from being established, the Signaller must inform the Catenary manager about the reason for the rejection and, if possible, agree on an alternative timing for establishing.
3891	Signaller		If there are no conditions which prevents the <a href="#">catenary isolation</a> from being established, the Signaller must ensure that no electrical <a href="#">rolling stock</a> has <a href="#">authority to move</a> in, or into, the catenary sections where the power will be isolated. The Signaller must then ensure, that the <a href="#">electrical rolling stock restriction</a> is activated in the <a href="#">signalling system</a> .
2326	Signaller		If there is electrical <a href="#">rolling stock</a> parked in the area, the Signaller must contact the relevant Railway Undertakings to request that the pantographs are lowered and all electrical rolling stock in the area closes down their driving desks.
2327	Railway Undertaking		The Railway Undertaking has procedures ensuring lowering and reporting on lowered pantographs when requested.
2328	Signaller		When confirmation from the Railway Undertakings is received that parked electrical <a href="#">rolling stock</a> in the affected area has lowered their pantographs and all electrical rolling stock have closed their desks, the Signaller may authorise the Catenary manager to establish the <a href="#">catenary isolation</a> .
3859	Signaller		The Signaller must ensure that the establishing time of the <a href="#">catenary isolation</a> and other relevant information is recorded in the <a href="#">Signaller log</a> .
2331	Catenary manager		When the Catenary manager receives authorisation from the Signaller the Catenary manager may isolate the power to the catenary sections specified in the agreed <a href="#">catenary isolation</a> plan.

## Catenary isolation

3595		<b>Electrical rolling stock in earthed area</b>
3596	Precondition	Electrical rolling stock has entered into an earthed area.
3597	Purpose	Ensure that the earthing arrangements in the earthed area has been checked and fit for purpose before work continues.
		<b><u>PROCEDURE</u></b>
3598	Signaller	<p>If electrical <b>rolling stock</b> has entered into an earthed area, the Signaller must immediately inform the PICOSS and the Catenary manager.</p> <p>Informing the PICOSS is done via the PICOP when a <b>possession</b> is established in connection with the <b>catenary isolation</b>. When no possession is established in connection with the catenary isolation, the information is provided via the Catenary manager.</p>
3599	PICOSS	<p>When the PICOSS is informed that electrical <b>rolling stock</b> has entered into an earthed area, the PICOSS must ensure that all work is stopped immediately.</p> <p>The PICOSS must ensure that the work is not continued until the Catenary manager has reported that it is safe to do so.</p>
3600	Catenary manager	When the Catenary manager is informed that electrical <b>rolling stock</b> has entered into an earthed area, the Catenary manager must instruct the Catenary field leader to check <b>earthing</b> arrangements in the isolated area and report back
3601	Catenary manager	When the Catenary field leader has reported that all <b>earthing</b> arrangements are checked and found fit for purpose, the Catenary manager must inform the Catenary field leader and the Signaller that work can continue.

## Catenary isolation

2343		
		<b>End catenary isolation</b>
2344	Precondition	The work task taking place under catenary isolation has ended.
2345	Purpose	Ensure that electrical power is safely restored in the isolated catenary sections.
		<b><u>PROCEDURE</u></b>
2347	Catenary manager	The Catenary manager may restore electrical power to the isolated catenary sections when the Catenary field leader confirms that work has ended and the <a href="#">earthing</a> arrangements have been removed. The Catenary manager must inform the Signaller when electrical power has been restored.
2350	Signaller	When the Catenary manager reports that electrical power has been restored, the Signaller must ensure that the <a href="#">electrical rolling stock restriction</a> is deactivated.  The Signaller must then inform any Railway Undertaking with parked electrical <a href="#">rolling stock</a> in the area that the <a href="#">catenary isolation</a> has been ended.
2351	Signaller	The Signaller must ensure that the end time of the <a href="#">catenary isolation</a> is recorded in the <a href="#">Signaller log</a> .
2352	Signaller	When the <a href="#">catenary isolation</a> has ended the Signaller may resume normal operation with electrical <a href="#">rolling stock</a> .

## Catenary isolation

2355		<b>Emergency catenary isolation</b>
2356	Precondition	The need for an immediate catenary isolation has occurred.
2357	Purpose	Handling of an emergency catenary isolation to reduce the risk of injury to people or damage to trains, vehicles or infrastructure.
		<b><u>PROCEDURE</u></b>
2358	Catenary manager	<p>The Catenary manager must assess in which catenary sections the power must be isolated and then ensure that the isolation is performed.</p> <p>When the power is isolated, the Catenary manager must inform the Signaller.</p>
2362	Signaller	<p>When the Signaller has received information about an emergency isolation in one or more catenary sections, the Signaller must ensure that all driving in the area is stopped by applying the procedure <a href="#">Emergency - Stop trains and vehicles from entering hazardous area</a>. The Signaller must then ensure that the <a href="#">electrical rolling stock restriction</a> is activated in the signalling system.</p>
3892	Signaller	<p>If there is electrical rolling stock in the area, the Signaller must contact the Driver and inform that the pantographs must be lowered and the desk must be closed.</p> <p>If there is electrical rolling stock parked in the area, the Signaller must contact the relevant Railway Undertakings to request that the pantographs are lowered and the driving desks are closed.</p>
3860	Signaller	The Signaller must inform the Catenary manager when all driving in the area has been stopped.
3861	Signaller	The Signaller must ensure that the establishing time of the <a href="#">emergency catenary isolation</a> and other relevant information is recorded in the <a href="#">Signaller log</a> .
3862	Catenary manager	When the Signaller reports that all driving in the area has been stopped, the Catenary manager may allow <a href="#">earthing</a> arrangements to be performed.



## Catenary isolation

2366		<b>Emergency catenary isolation requested by Emergency services</b>
2367	Precondition	The Emergency services has requested the Network manager for an emergency catenary isolation for the sake of their work. The Network manager has informed the Catenary manager. All driving in the area has been stopped.
2368	Purpose	Ensure safe working conditions for the Emergency services.
<b><u>PROCEDURE</u></b>		
3863	Catenary manager	<p>The Catenary manager must use the information provided from the Network manager to assess in which catenary sections the power must be isolated and then ensure that the isolation is performed.</p> <p>When the power is isolated, the Catenary manager must inform the Signaller and request a confirmation that all driving in the area has been stopped.</p>
2370	Signaller	When the Catenary manager reports that an <a href="#">emergency catenary isolation</a> has been performed in one or more catenary sections, the Signaller must ensure that the <a href="#">electrical rolling stock restriction</a> is activated in the signalling system.
3893	Signaller	<p>If there is electrical rolling stock in the area, the Signaller must contact the Driver and inform that the pantographs must be lowered and the desk must be closed.</p> <p>If there is electrical rolling stock parked in the area, the Signaller must contact the relevant Railway Undertakings to request that the pantographs are lowered and the driving desks are closed.</p>
3864	Signaller	The Signaller must ensure that the establishing time of the <a href="#">emergency catenary isolation</a> and other relevant information is recorded in the <a href="#">Signaller log</a> .
3865	Catenary manager	When the Signaller is informed about the <a href="#">emergency catenary isolation</a> and all driving in the area has been stopped, the Catenary manager may allow <a href="#">earthing</a> arrangements to be performed. The permission is given via the Network manager.

## Catenary isolation

2376		<b>End emergency catenary isolation</b>
2377	Precondition	An emergency catenary isolation has been established. The Catenary field leader has arrived on the scene.
2378	Purpose	To safely initiate the end of an emergency catenary isolation.
		<b><u>PROCEDURE</u></b>
2381	Catenary manager	If an <a href="#">emergency catenary isolation</a> was requested by <a href="#">Emergency services</a> , the Catenary Manger must be instructed by the Network manager that the isolation is no longer needed, before ending the emergency isolation.
2382	Catenary manager	When the <a href="#">emergency catenary isolation</a> is no longer needed, the Catenary Manger must initiate the procedure <a href="#">Catenary isolation - End catenary isolation</a> .

2788			<b>Train failure</b>
2789			<b>Train and/or onboard failure during a mission</b>
2790	Precondition		A train and/or onboard failure has been detected by the Driver.
2791	Purpose		Informing the Signaller of the failure and update of the production plan to incorporate failure related changes.
			<b><u>PROCEDURE</u></b>
2792	Railway Undertaking		<p>The Railway Undertaking must have procedures, for handling train and/or <a href="#">onboard</a> failures, enabling Drivers to:</p> <ul style="list-style-type: none"> <li>- bring trains back into service including any necessary restriction on train capabilities</li> <li>- determine if the train is not to be moved</li> <li>- determine need to isolate the onboard.</li> </ul>
2793	Driver		When at standstill the Driver must inform the Signaller of expected timeframe for failure investigation/attempt at failure correction. The Driver must expect any <a href="#">movement authority</a> to be shortened immediately.
3770	Driver		If the investigation of the failure requires the Driver to leave the cab, the Driver may request the Signaller to provide additional protection by applying the procedure <a href="#">Incidents - Signaller protected area requested by staff</a> .
2795	Signaller		<p>When the Signaller is informed of an unplanned standstill the Signaller must mark the train with the <a href="#">failed train marking</a>, and ensure that the route associated to the failed train is released.</p> <p>The Signaller must use the information on an expected timeframe for fault investigation to update routing of trains to minimise impact to the <a href="#">production plan</a>.</p>
2796	Driver		<p>The Driver must examine the train to determine the failure.</p> <p>If the failure can be resolved with no restrictions the Driver must inform the Signaller.</p> <p>If the failure can be resolved but restrictions must be applied, the Driver must inform the Signaller about the restrictions.</p> <p>If the failure can only be resolved by the Driver isolating the <a href="#">onboard</a> the Driver must inform the Signaller before isolating.</p> <p>If the train cannot be moved, the Driver must inform the Signaller.</p>

3771	Driver	<p>If the Driver during the investigation needs to inspect the loading of a wagon, the Driver must ensure that the inspection can be done without violating the protective distance as well as ensuring, that no part of the wagon or its load has come into contact with the catenary system</p> <p>If the conditions listed above cannot be met, the Driver must inform the Signaller that the inspection of the load cannot be performed unless the Catenary manager has reported that the power is switched off, and that <a href="#">earthing</a> arrangements has been put in place.</p>
2797	Signaller	<p>If the Driver requests a new <a href="#">movement authority</a> with no information on restricted train capabilities the Signaller must remove the <a href="#">failed train marking</a> to allow a new movement authority for the train.</p>
2798	Signaller	<p>If the Signaller is informed by the Driver that the train has restricted capabilities the Signaller must:</p> <ol style="list-style-type: none"> <li>1. Update the <a href="#">production plan</a> to incorporate and minimise the effect of the restricted capabilities according to the procedure <a href="#">Normal operation - Handling changes to operation</a></li> <li>2. Remove the <a href="#">failed train marking</a> to allow a new <a href="#">movement authority</a> for the train.</li> </ol>
3549	Signaller	<p>If the Signaller is informed by the Driver that the <a href="#">onboard</a> is isolated the Signaller must initiate the procedure <a href="#">Train failure - Isolate onboard</a>.</p>
2799	Signaller	<p>If the Signaller is informed by the Driver that the train is not to be moved the Signaller must initiate the procedure <a href="#">Train failure - Assisting a disabled train</a>.</p>

## Train failure

2816		<b>Isolate onboard</b>
2817	Precondition	A failure in the onboard requires the onboard to be isolated to allow the train to be moved. The Driver has informed the Signaller that the onboard will be isolated.
2818	Purpose	To allow the train to be moved with the onboard isolated.
		<b><u>PROCEDURE</u></b>
2819	Signaller	<p>When the Signaller is informed by the Driver that the <a href="#">onboard</a> needs to be isolated the Signaller must make an entry into the Signaller log and assess if the <a href="#">train</a> have to be moved.</p> <p>If passengers are trapped on the train the Signaller may follow the procedure <a href="#">Degraded operation - Authorised passing of the end of authority</a> to <a href="#">route</a> the train into the nearest convenient platform to disembark the passengers.</p> <p>If the train is at a standstill at a location where traffic operation is impeded the Signaller may follow the procedure <a href="#">Degraded operation - Authorised Passing of the end of authority</a> to route the train into a convenient location.</p>
2821	Signaller	<p>When the <a href="#">train</a> has been moved to a location where it will not impede traffic operation or it is convenient to disembark passengers, the Signaller must:</p> <ol style="list-style-type: none"> <li>1. Inform the Driver that the service of the train has ended</li> <li>2. Initiate the procedure <a href="#">Train Failure - Assisting a disabled train</a>.</li> </ol>

## Train failure

2825		<b>Assisting a disabled train</b>
2826	Precondition	A train is disabled. The Driver has determined that the train cannot be moved.
2827	Purpose	To assist a disabled train either by repairing it on site or moving it by an assisting train.
		<b><u>PROCEDURE</u></b>
2828	Driver	The Driver must inform the Signaller of:  - location of train - relevant description of problem - kind of help needed.
2829	Signaller	The Signaller must pass information received from the Driver on to the Network manager.
2831	Signaller	The Signaller must ensure that the Driver on the <a href="#">disabled train</a> is informed that an <a href="#">assisting train</a> is approaching and from which direction.  Before setting a route to a track section where a disabled train is located, the Signaller must ensure that the Driver of the assisting train is informed that the train is entering an occupied section.
2832	Signaller	The Signaller must initiate the procedure <a href="#">Normal operation - Planned joining</a> .

## Train failure

3275			<b>Prepare an assisting train after joining</b>
3276	Precondition		An assisting train has been coupled to a stationary disabled train.
3277	Purpose		To determine under which conditions the train can be moved.
			<b><u>PROCEDURE</u></b>
3278	Railway Undertaking		<p>The Railway Undertaking must have procedures, for handling <a href="#">train</a> failures, enabling Drivers to:</p> <ul style="list-style-type: none"> <li>- bring trains back into service including determining any necessary restrictions on train capabilities</li> <li>- determine need to isolate onboard</li> <li>- determine train not to be moved.</li> </ul> <p>The Railway Undertaking must have procedures describing how to coordinate with the Network manager and pass on the information regarding the failed train.</p>
3279	Driver		When the <a href="#">train</a> is <a href="#">safe and fit for service</a> , and a valid timetable is available, the Driver must apply the procedure <a href="#">Normal operation - Enter onboard train data</a> .
3280	Driver		If the <a href="#">train</a> is not <a href="#">safe and fit for service</a> the Driver must apply the procedure <a href="#">Train failure - Moving defective rolling stock</a> .

## Train failure

3306			<b>Moving defective rolling stock</b>
3307	Precondition		Rolling stock cannot be made safe for normal operation, but has to be moved.
3308	Purpose		Moving defective rolling stock to a non interlocked area or depot with restrictions.
			<b><u>PROCEDURE</u></b>
3309	Railway Undertaking		<p>The Railway Undertaking must have procedures for inspecting and moving defect <a href="#">rolling stock</a>. The procedure states how the rolling stock is prepared, the conditions for moving it and at what speed the defective rolling stock can be moved.</p> <p>The procedure describes the communication to the Network manager.</p>
3311	Driver		The Driver must inform the Signaller when the defective <a href="#">rolling stock</a> is ready to be moved, and confirm the restrictions under which the defective rolling stock is to be moved.
3312	Signaller		<p>When the Signaller receives confirmation that the defective <a href="#">rolling stock</a> is ready to be moved the Signaller must:</p> <ol style="list-style-type: none"> <li>1. Arrange with the Driver the establishment of a <a href="#">temporary shunting area</a> and necessary safety precaution as planned by the Network manager</li> <li>2. Instruct the Driver about the <a href="#">shunting movement</a> to be performed</li> <li>3. Ensure that no <a href="#">trains</a> or <a href="#">vehicles</a> have <a href="#">authority to move</a> within the temporary shunting area.</li> </ol>
3313	Signaller		When the <a href="#">temporary shunting area</a> is set up and protected the Signaller may authorise the Driver to proceed.
3314	Driver		When authorised to proceed by the Signaller the Driver may perform the <a href="#">shunting movement</a> as instructed.
3315	Driver		When the <a href="#">shunting movement</a> has been completed, and the defective <a href="#">rolling stock</a> is at a standstill, the Driver must ensure that the rolling stock is complete. The Driver must contact the Signaller and report that the defective rolling stock is complete and that the shunting movement is ended.
3316	Signaller		When the Driver reports the defective <a href="#">rolling stock</a> complete and the <a href="#">shunting movement</a> ended, the Signaller may end the <a href="#">temporary shunting area</a> .



2875		<b>Weather conditions</b>	
2876		<b>Handling of wind restrictions</b>	
2877	Precondition		Wind has risen above the specified level.
2878	Purpose		Ensuring that all relevant wind restrictions described in the location specific description are implemented and respected.
		<b><u>PROCEDURE</u></b>	
2880	Signaller		<u>Temporary speed restrictions</u> , with associated text messages, are predefined in the <u>signalling system</u> for areas with foreseeable high wind influence. These temporary speed restrictions can be quickly activated by the Signaller upon receiving an alarm.
2881	Signaller		When the Signaller receives an alarm of high winds the Signaller must immediately implement <u>wind restrictions</u> in the <u>signalling system</u> according to the <u>location specific description</u> for the area concerned.
			Before activating a wind restriction, the Signaller must take into account that some types of wind restrictions are valid for specific train types only.
			When wind related restrictions are implemented the Signaller must inform the Network manager.

## Weather conditions



2884		<b>Removal of wind restrictions</b>
3592	Precondition	The speed of the wind is below the speed stated in location specific descriptions.
2885	Purpose	Removal of wind related restriction when wind speed has dropped sustainably.
		<b><u>PROCEDURE</u></b>
2887	Signaller	When the conditions in the location specific description are met the Signaller may remove <a href="#">wind restrictions</a> .
2888	Signaller	The Signaller must inform the Network manager when <a href="#">wind restrictions</a> are removed.

## Weather conditions

2861		<b>Snow clearing</b>
2862	Precondition	A snow clearing train is prepared with snow ploughs coupled to it front and rear.
2863	Purpose	Update train data and ensure that the driving of the snow clearing train is performed safely.
		<b><u>PROCEDURE</u></b>
2865	Driver	When snow ploughs has been coupled to the <a href="#">train</a> front and rear, the Driver must update the <a href="#">onboard</a> train data according to the procedure <a href="#">Normal operation - Update onboard train data</a> .
2866	Driver	The Driver must contact the Signaller and report the <a href="#">snow clearing train</a> ready.
2868	Signaller	When the Driver reports the <a href="#">snow clearing train</a> ready, the Signaller must ensure that no other <a href="#">trains</a> or <a href="#">vehicles</a> has <a href="#">authority to move</a> in, or into, the <a href="#">track sections</a> behind and in front of the snow clearing train.  The Signaller must use manual <a href="#">route</a> setting for the snow clearing train.
2869	Driver	If large snow drifts require the Driver to change driving direction in order to get a longer run up, the Driver must inform the Signaller.  The Driver must close down the desk of the lead cab, proceed to the other cab and apply the procedure <a href="#">Normal operation - Enter onboard train data</a> .
2871	Signaller	When the Signaller is informed about the need for changing driving direction, the Signaller must use manual <a href="#">route</a> setting for the <a href="#">snow clearing train</a> in the opposite direction.
2872	Driver	The Driver must report to the Signaller when driving has finished and the <a href="#">snow clearing train</a> is at a standstill.

3329			<h2>Shunting</h2>
3330			<h3>Prepare shunting movement</h3>
3331	Precondition		A train or vehicle is to be moved as a shunting movement.
3332	Purpose		Ensure that shunting movements are only carried out with rolling stock that is safe for shunting movements and necessary instructions are provided.
			<b><u>PROCEDURE</u></b>
3333	Railway Undertaking		<p>The Railway Undertaking must have procedures describing how:</p> <ul style="list-style-type: none"> <li>- <a href="#">traction units</a> are prepared prior to <a href="#">shunting movements</a></li> <li>- it is checked that the <a href="#">rolling stock</a> is <a href="#">safe for shunting movement</a></li> <li>- safe <a href="#">coupling</a> of rolling stock is performed.</li> </ul>
3334	Driver		The Driver must ensure the <a href="#">traction unit</a> is <a href="#">safe for shunting movement</a> prior to engaging in <a href="#">shunting movements</a> .
3335	Shunter		<p>The Shunter must plan the <a href="#">shunting movement</a> to take place inside a <a href="#">permanent shunting area</a>, a temporary shunting area, a <a href="#">possession</a> or on a <a href="#">route for shunting</a>.</p> <p>The Shunter may request assistance from the Signaller when planning for a temporary shunting area or a route for shunting.</p>
3336	Shunter		The Shunter must coordinate all movements within a <a href="#">permanent shunting areas</a> (if applicable), temporary shunting areas and <a href="#">possessions</a> with the Shunting area manager.
3337	Signaller		If requested by a Shunter the Signaller must provide assistance in planning a <a href="#">shunting movement</a> , assessing the optimum use of a temporary shunting area or <a href="#">route for shunting</a> .
3338	Shunter		The Shunter must ensure that only <a href="#">rolling stock</a> that meets Railway Undertaking requirements to be <a href="#">safe for shunting movement</a> is added to the consist of a <a href="#">shunting movement</a> and <a href="#">coupling</a> of rolling stock is performed according to Railway Undertaking procedures.
3339	Shunter		<p>The Shunter must instruct the Driver prior to the <a href="#">shunting movement</a> to ensure the movement can be controlled safely within the area of control of the Shunter. The instruction must contain sufficient information for the Driver to recognise the boundary of the area appointed for the shunting movement.</p> <p>If the shunting movement is to be controlled by use of a radio, the Shunter must instruct the Driver about which number to use for communication.</p> <p>If the shunting movement is performed without the use of radio or mobile telephone, the Shunter must control the shunting movement using hand signals.</p>

## Shunting

3342		<b>Shunting on a route using a handheld terminal</b>
3343	Precondition	A Shunter has identified the need for an immediate shunting movement with no intermediate stops, to take place outside of a shunting area. The movement cannot be controlled from the front cab. The Shunter has a handheld terminal available.
3344	Purpose	To enable a safe movement outside a shunting area without an active desk in front of the direction of travel.
<b><u>PROCEDURE</u></b>		
3345	Signaller, Shunter	 <p>Planned <a href="#">routes for shunting</a> can be requested by a <a href="#">handheld terminal</a> and will consist of a <a href="#">route</a> that will be released behind the movement as the movement travels through the route.</p> <p>Once the <a href="#">train</a> is in <a href="#">SH-mode</a>, the data communication is ended with the <a href="#">signalling system</a>. Therefore, to receive new information the train must <a href="#">exit SH-mode</a> to re-establish a communication session with the signalling system.”</p>
3346	Shunter	The Shunter must use the <a href="#">handheld terminal</a> to request the planned <a href="#">route for shunting</a> .
3347	Signaller, Shunter	 <p>The <a href="#">signalling system</a> will assess requests for <a href="#">routes for shunting</a> for possible operational conflicts with other <a href="#">routes</a>. The signalling system will request the Signaller to acknowledge, change or reject a proposed route for shunting before the route is automatically set.</p>
3348	Signaller	<p>If the Signaller receives a request from the <a href="#">signalling system</a> to set <a href="#">route for shunting</a>, the Signaller must perform one of the following actions:</p> <ul style="list-style-type: none"> <li>- accept the proposed route for shunting</li> <li>- manually update the timing of the proposed route for shunting</li> <li>- reject the route for shunting.</li> </ul>
3349	Shunter	<p>When a <a href="#">route for shunting</a> is indicated as granted on the <a href="#">handheld terminal</a>, the Shunter must instruct the Driver to select <a href="#">SH-mode</a>, if the <a href="#">train</a> is not already in SH-mode, and perform the shunting movement.</p> <p>The Shunter must ensure the shunting movement:</p> <ul style="list-style-type: none"> <li>- is performed immediately</li> <li>- is run in the forward direction of the route for shunting only</li> <li>- concludes without intermediate stops</li> <li>- ends at the planned location.</li> </ul>

3744	Shunter	<p>The Shunter must ensure that all level crossings included in the <a href="#">route for shunting</a> are activated and are protected, just prior to the passing. The Shunter must ensure that level crossings are deactivated immediately after passing the level crossing.</p> <p>If a level crossing cannot be protected, and the cab is in the forward facing end of the movement, the Shunter must instruct the Driver to use sound signal "Warning" until the cab has cleared the level crossing. If the cab is not in the forward facing end of the movement, the Shunter must stop the road traffic by using hand signal "Road traffic, stop". When the hand signal is used, the Shunter must instruct the Driver not to use sound signal "Warning" during the passing of the level crossing.</p>
3350	Shunter	<p>When the shunting movement has reached the end location of the <a href="#">route for shunting</a>, and the location is outside a possession or <a href="#">shunting area</a>, the Shunter must apply the procedure <a href="#">Shunting - Exit SH-mode</a>.</p>
3351	Shunter	<p>If a request for a <a href="#">route for shunting</a> is rejected, the Shunter must perform one of the following actions:</p> <ul style="list-style-type: none"><li>- request the <a href="#">route</a> at another time</li><li>- request another route</li><li>- contact the Signaller to plan an alternative solution.</li></ul>

## Shunting

3354		<b>Shunting on a route without using a handheld terminal</b>
3355	Precondition	A Shunter has identified the need for an immediate shunting movement with no intermediate stops, to take place outside of a shunting area. The movement cannot be controlled from the cab in the front end of the train. No handheld terminal is available.
3356	Purpose	To enable a safe shunting movement outside a shunting area where the train cannot be controlled from a cab in the front end of the train.
<b><u>PROCEDURE</u></b>		
3358	Shunter	<p>The Shunter must contact the Signaller and request the <a href="#">route for shunting</a>. The request for a route for shunting must contain the start and end location of the route.</p> <p>If the route for shunting is to be used by a <a href="#">train</a> the request must include the train running number. If no train running number is available the fixed <a href="#">traction unit</a> number, of the unit from which the train is driven, is used. The Shunter must ensure the train is not in <a href="#">SH-mode</a> when the route is requested.</p>
3359	Signaller	<p>The Signaller must assess the request for conflicts with other routes. If the end location for the <a href="#">route for shunting</a> is in a <a href="#">possession</a> or <a href="#">shunting area</a>, the Signaller must first contact the PICOP or Shunting area manager and request permission for the movement.</p> <p>When the route for shunting is set, the Signaller must verify that the indication on the <a href="#">signalling control display</a> is correct and then authorise the Shunter to perform the shunting movement.</p>
3360	Shunter	<p>When the Signaller grants a <a href="#">route for shunting</a>, the Shunter must instruct the Driver to select <a href="#">SH-mode</a>, if the <a href="#">train</a> is not already in SH-mode, and perform the shunting movement.</p> <p>The Shunter must ensure the shunting movement:</p> <ul style="list-style-type: none"> <li>- is performed immediately</li> <li>- is run in the forward direction of the route for shunting only</li> <li>- concludes without intermediate stops</li> <li>- ends at the planned location.</li> </ul>
3745	Shunter	<p>The Shunter must ensure that all level crossings included in the <a href="#">route for shunting</a> are activated and is protected just prior to the passing. The Shunter must ensure that level crossings are deactivated immediately after passing the level crossing.</p> <p>If a level crossing cannot be protected, and the cab is in the forward facing end of the movement, the Shunter must instruct the Driver to use sound signal "Warning" until the cab has cleared the level crossing. If the cab is not in the forward facing end of the movement, the Shunter must stop the road traffic by using hand signal "Road traffic, stop". When the hand signal is used, the Shunter must instruct the Driver not to use sound signal "Warning" during the passing of the level crossing.</p>

3361 Shunter

When the shunting movement has reached the end location of the [route for shunting](#), and the location is outside a [possession](#) or [shunting area](#), the Shunter must apply the procedure [Shunting - Exit SH-mode](#).



## Shunting

3372			<b>Shunting movement</b>
3373	Precondition		A shunting movement is to be performed on a shunting route, inside a possession or shunting area.
3374	Purpose		To perform a shunting movement on a shunting route, inside a possession or shunting area.
			<b><u>PROCEDURE</u></b>
3375	Shunter		<p><u>Interlocked points</u> inside <u>possessions</u> or <u>temporary shunting areas</u> are released for local control if not locked for protective purposes. The <u>handheld terminal</u> can be used to throw the lie of the point inside possessions or temporary shunting areas.</p> <p>The lie of points is not indicated on the handheld terminal.</p>
3376	Shunter		<p>The Shunter must protect the <u>shunting movement</u> by ensuring:</p> <ul style="list-style-type: none"> <li>- points are in the <u>correct lie</u> for the movement</li> <li>- obstacles that may cause a hazardous situation are avoided</li> <li>- the shunting movement will not come into conflict with other shunting movements in the area</li> <li>- level crossings included in the shunting movement are activated via the local control box and protected.</li> </ul> <p>If a level crossing cannot be protected, and the cab is in the forward facing end of the movement, the Shunter must instruct the Driver to use sound signal "Warning" until the cab has cleared the level crossing. If the cab is not in the forward facing end of the movement, the Shunter must stop the road traffic by using hand signal "Road traffic, stop". When the hand signal is used, the Shunter must instruct the Driver not to use sound signal "Warning" during the passing of the level crossing.</p> <p>Throughout the shunting movement the Shunter must be located in a position from where as much of the shunting path can be observed, and as far as possible, continually ensure the conditions listed above are met.</p>
3603	Shunter		<p>When performing <u>shunting movements</u> in areas with public access the Shunter must ensure that yellow flashing light on the traction unit is activated if mounted.</p> <p>When performing shunting movements in areas with public access in darkness or low visibility the Shunter must ensure that first and last vehicle is marked with yellow flashing light.</p>
3741	Shunter		If the <u>shunting movement</u> is controlled by using a radio or a mobile telephone, the Shunter must use verbal control tone. The Shunter must use verbal control tone by transmitting the message "Continue" with a maximum of five second intervals when no other messages needs to be exchanged.



## Shunting

3382			<b>Start shunting from SB-mode</b>
3383	Precondition		The Driver of a train in SB-mode inside a possession, shunting area or on a shunting route has been instructed by a Shunter to request SH-mode.
3384	Purpose		To authorise the train in SB-mode to enter into SH-mode.
			<b><u>PROCEDURE</u></b>
3385	Driver		The Driver must press the "Shunting" button on the <a href="#">DMI</a> to request <a href="#">SH-mode</a> from the <a href="#">signalling system</a> .
3386	Driver, Signaller, Shunter		<p>If the <a href="#">train</a> is inside an active <a href="#">shunting area</a>, <a href="#">possession</a> or on a shunting route, and the position of the train can be validated by the <a href="#">signalling system</a>, the request to enter <a href="#">SH-mode</a> will be accepted.</p> <p>If the position of the train can be validated by the signalling system, but the train is outside an active shunting area, possession or on a shunting route, or if the position of the train cannot be validated, the request to enter SH-mode will be refused.</p> <p>The text message "SH refused" will be indicated to the Driver on the <a href="#">DMI</a>.</p>
3708	Driver		If the text message "SH refused" is displayed on the <a href="#">DMI</a> , the Driver must inform the Shunter.
3709	Shunter		If the Driver reports that the request to enter <a href="#">SH-mode</a> has been refused by the <a href="#">signalling system</a> , the Shunter must inform the Signaller.
3387	Signaller		<p>If the Signaller is informed by the Shunter that the request to enter <a href="#">SH-mode</a> has been refused, the Signaller must assess if the reason for the refusal is because the position of the <a href="#">train</a> cannot be validated by the <a href="#">signalling system</a>.</p> <p>If the reason for the refusal is that the position of the train cannot be validated, the Signaller must establish the location of the train in cooperation with the Shunter.</p>
3388	Signaller		<p>If the location of the <a href="#">train</a> is established within an active <a href="#">shunting area</a>, a <a href="#">possession</a> or a shunting route, the Signaller must activate the special function which will allow the <a href="#">signalling system</a> to accept the train's next request to enter <a href="#">SH-mode</a>. The Signaller must inform the Shunter that another press of the "Shunting" button will be necessary.</p> <p>If the train is not located within an active shunting area, a possession or a shunting route, the Signaller must inform the Shunter that the train is located in an area where shunting is not permitted.</p>

## Shunting

3826		<b>Shunting between possessions or shunting areas</b>
3827	Precondition	Two possessions or shunting areas, or a possession and a shunting area, is located right after each other, separated by one or more axle counter sections. There is a need to drive a train or vehicle from one area to the other.
3829	Purpose	Make the required agreements between the two Shunting area managers (referred to as Shunting area manager A and B) and the Signaller and perform the shunting movement.
<b><u>PROCEDURE</u></b>		
3831	Shunting area manager	The <u>Shunting area</u> manager must contact the Signaller and request permission for a <u>train</u> or <u>vehicle</u> to perform a <u>shunting movement</u> to the neighbouring area.
3832	Signaller	<p>After request from <u>Shunting area</u> manager A, the Signaller must contact Shunting area manager B and request permission for a <u>train</u> or <u>vehicle</u> to perform a <u>shunting movement</u> into the area.</p> <p>When Shunting area manager B has given permission, the Signaller must, as far as possible, protect the shunting movement between the two areas.</p> <p>The Signaller must then inform Shunting area manager A that the shunting movement can be started.</p>
3833	Shunting area manager	When the Signaller has given permission to start the <u>shunting movement</u> , the <u>Shunting area</u> manager must inform the Shunter.
3834	Shunter	Before the <u>shunting movement</u> is started, the Shunter must contact <u>Shunting area</u> manager B and request that relevant information, which effect shunting movements inside the area, is handed over.
3835	Shunter	The Shunter must inform <u>Shunting area</u> manager B when the <u>train</u> or <u>vehicle</u> has arrived in the area.
3836	Shunting area manager	<u>Shunting area</u> manager B must inform the Signaller when the <u>train</u> or <u>vehicle</u> has arrived in the area.

## Shunting

3880		<p><b>Shunting movement past the system border between possessions in the transition area</b></p>
3881	Precondition	<p>Possessions are established on both sides of the system border in the transition area. A working unit has to pass the system border from one possession to the other.</p>
3882	Purpose	<p>Ensure that the onboard is always in SH-mode, when shunting movements are performed in the transition area.</p>
<p><b><u>PROCEDURE</u></b></p>		
3884	PICOP	<p>The PICOP may allow <u>shunting movements</u> past the <u>system border</u> without further authorisation from the Signaller or <u>Legacy signaller</u>.</p>
3885	Driver	
<p>When the <u>onboard</u> is in <u>SH-mode</u> and reads the balise at the <u>system border</u>, the level change is stored and will be executed when the onboard exits SH-mode.</p>		
3886	Driver	<p>The Driver must ensure that the <u>onboard</u> is in <u>SH-mode</u> before <u>shunting movements</u> are performed in possessions in the transition area regardless of which side of the <u>system border</u>, the <u>working unit</u> is located.</p>
3887	Driver	<p>The <u>working unit</u> may leave a possession in the transition area only when the Driver has ensured, that the <u>indicated running level</u> is level 2</p>

## Shunting

3400		<b>Exit SH-mode</b>
3401	Precondition	A train has concluded its shunting movement in a possession, a shunting area or on a shunting route.
3402	Purpose	To ensure that no trains remain in SH-mode once shunting is concluded.
		<b><u>PROCEDURE</u></b>
3403	Shunter	The Shunter must inform the Driver of a <a href="#">train</a> that shunting is concluded.
3404	Driver	When shunting is concluded, the Driver must <a href="#">exit SH-mode</a> and inform the Shunter.
3405	Shunter	When the Driver has confirmed <a href="#">exiting SH-mode</a> , the Shunter must inform the <a href="#">Shunting area</a> manager that the <a href="#">train</a> under their control has completed the required <a href="#">shunting movements</a> and has exited <a href="#">SH-mode</a> .

## Shunting



3392		<b>Leaving a possession or shunting area</b>
3393	Precondition	A train has finished work within a possession or shunting area and is ready to shunt towards the exit ETCS stop marker.
3394	Purpose	To get the train to the exit ETCS stop marker of the area and ready to leave the area as a supervised movement.
		<b><u>PROCEDURE</u></b>
3395	Shunting area manager	Prior to allowing a <a href="#">train</a> to drive to the exit ETCS stop marker of the area, the <a href="#">Shunting area</a> manager must ensure that this is according to planned sequence or is agreed with the Signaller.
3396	Shunter	The Shunter must come to an agreement with the <a href="#">Shunting area</a> manager before a <a href="#">train</a> can shunt to the exit ETCS stop marker of the area. In case no Shunting area manager is assigned, the agreement is made with the Signaller.
3397	Driver	The Driver must drive as close as possible to the exit ETCS stop marker according to instructions received from the Shunter.  If the area is equipped with a "Stop at danger point" marker, the Driver must stop the <a href="#">train</a> in front of the marker instead.
3398	Driver	To leave the <a href="#">possession</a> or <a href="#">shunting area</a> the Driver must first press "Exit Shunting" if not in <a href="#">SB-mode</a> . When the <a href="#">train</a> is in SB-mode the Driver may apply procedure <a href="#">Normal operation - Enter onboard train data</a>

## Shunting

3847			<b>Planning of a temporary shunting area</b>
3848	Precondition		The need for a temporary shunting area is identified. The area is not planned in advance.
3849	Purpose		Planning of a temporary shunting area and agreeing the boundaries and timing of the area.
			<b><u>PROCEDURE</u></b>
3851	Shunting area manager		<p>The Shunting area manager must contact the Signaller and request a <a href="#">temporary shunting area</a>. If the requested area is defined in the <a href="#">location specific description</a>, the Shunting area manager must use the area name or number from there to specify the boundaries of the area.</p> <p>The request must contain a specification of:</p> <ul style="list-style-type: none"> <li>- location</li> <li>- the <a href="#">ETCS stop markers</a> and buffer stops marking the boundaries of the area</li> <li>- timing.</li> </ul>
3852	Signaller		<p>The Signaller must ensure that the <a href="#">temporary shunting area</a> is planned in the <a href="#">signalling system</a> according the request of the Shunting area manager.</p> <p>The Signaller must ensure that the planning is checked and approved by another person with competences as a Signaller.</p> <p>If the area cannot be planned as requested, the Signaller must inform the Shunting area manager and, if possible, plan an alternative.</p>
3853	Signaller		The ID-number of the <a href="#">temporary shunting area</a> is assigned when the area is planned in the <a href="#">signalling system</a> .
3854	Signaller		When the <a href="#">temporary shunting area</a> is planned in the <a href="#">signalling system</a> , the Signaller must inform the Shunting area manager about area ID-number and the planned timing arrangements.





## Shunting

3408			<b>Establish temporary shunting area with handheld terminal</b>
3409	Precondition		The Shunting area manager is ready to establish a planned temporary shunting area and a handheld terminal is available.
3410	Purpose		Establish a planned temporary shunting area.
			<b><u>PROCEDURE</u></b>
3412	Shunting area manager		The Shunting area manager must use the <a href="#">handheld terminal</a> to request the planned <a href="#">temporary shunting area</a> .
3413	Signaller		The <a href="#">signalling system</a> can only activate a <a href="#">temporary shunting area</a> if all elements of the area are not locked by a route, or by an overlap, or reserved by another established temporary shunting area or possession.
3414	Signaller		Before the Signaller approves the request to establish a <a href="#">temporary shunting area</a> , the Signaller must assess if any conditions exist which prevent the area from being established as planned.
3841	Signaller		When the <a href="#">temporary shunting area</a> is indicated on the <a href="#">signalling control display</a> , the Signaller must check that the indication of the area is consistent with the planning. If the indication on the signalling control display is consistent with the planning, the Signaller must approve the establishing of the area.
3842	Signaller		If the indication of the <a href="#">temporary shunting area</a> on the <a href="#">signalling control display</a> is <b>NOT</b> consistent with the planning, the Signaller must reject the establishing of the area and as far as possible ensure that the area is re-planned in cooperation with the Shunting area manager.
3415	Shunting area manager		When the <a href="#">temporary shunting area</a> is established it will be indicated on the <a href="#">handheld terminal</a> and result in points within the temporary shunting area being released for local control by the handheld terminal.
3793	Signaller		The Signaller must ensure an entry in the <a href="#">Signaller log</a> when the <a href="#">temporary shunting area</a> is established.
3416	Shunting area manager		The Shunting area manager must assume responsibility for the <a href="#">temporary shunting area</a> when the <a href="#">handheld terminal</a> indicates that the requested temporary shunting area has been established.



## Shunting

3422			<b>Establish temporary shunting area without handheld terminal</b>
3423	Precondition		The Shunting area manager is ready to establish a planned temporary shunting area. No handheld terminal is available.
3424	Purpose		Establish a planned temporary shunting area.
			<b><u>PROCEDURE</u></b>
3426	Shunting area manager		<p>The Shunting area manager must contact the Signaller and request the establishing of the planned <a href="#">temporary shunting area</a>. The request must contain a specification of:</p> <ul style="list-style-type: none"> <li>- area ID-number.</li> <li>- location where the area must be established</li> <li>- Shunting area manager ID</li> <li>- <a href="#">radio ID</a> or mobile phone number</li> </ul>
3427	Signaller		The <a href="#">signalling system</a> can only activate a <a href="#">temporary shunting area</a> if all elements of the area are not locked by a <a href="#">route</a> , or by an overlap, or reserved by another established temporary shunting area or possession.
3428	Signaller		<p>The Signaller must manually request the <a href="#">temporary shunting area</a> in the <a href="#">signalling system</a>. Before the Signaller approves the request to establish a temporary shunting area, the Signaller must assess if any conditions exist which prevent the area from being established as planned.</p>
3843	Signaller		<p>When the <a href="#">temporary shunting area</a> is indicated on the signalling control display, the Signaller must check that the indication of the area is consistent with the planning. If the indication on the signalling control display is consistent with the planning, the Signaller must approve the establishing of the area.</p>
3844	Signaller		If the indication of the <a href="#">temporary shunting area</a> on the signalling control display is <b>NOT</b> consistent with the planning, the Signaller must reject the establishing of the area and as far as possible ensure that the area is re-planned in cooperation with the Shunting area manager.
3845	Signaller		<p>The Signaller must inform the Shunting area manager when the <a href="#">temporary shunting area</a> is established. The boundaries of the area must be included in the message. The Signaller must ensure that an entry is made in the <a href="#">Signaller log</a>.</p>
3429	Shunting area manager		The Shunting area manager must assume responsibility for the <a href="#">temporary shunting area</a> when the Signaller confirms that the area has been established.

## Shunting

3714		<b>Handover of a shunting area</b>	
3715	Precondition		A relieving Shunting area manager is ready to take over a shunting area from a responsible Shunting area manager.
3716	Purpose		To ensure that the relevant information is given to the relieving Shunting area manager and responsibility for the shunting area is transferred.
		<b><u>PROCEDURE</u></b>	
3717	Shunting area manager		The <a href="#">signalling system</a> will always require a Shunting area manager to be responsible for a temporary shunting area. There can also be a Shunting area manager for a permanent shunting area. The signalling system will only allow one responsible Shunting area manager for each shunting area. A Shunting area manager can be responsible for more than one shunting area.
3718	Shunting area manager		<p>The relieving Shunting area manager must:</p> <ul style="list-style-type: none"> <li>- request relevant information from the responsible Shunting area manager</li> <li>- inform the Signaller of the handover of the shunting area</li> <li>- inform the Signaller about contact possibilities and if any, ID of <a href="#">handheld terminal</a>.</li> </ul>
3719	Signaller		<p>The <a href="#">signalling system</a> cannot automatically update the information in the <a href="#">Signaller log</a> when the responsibility of a shunting area is handed over. The handover and contact information of the new shunting area manager will require a manual update by the Signaller.</p>
3720	Signaller		<p>When a Signaller is informed of handover of a shunting area, the Signaller must manually update the information in the <a href="#">Signaller log</a>. This update has to include:</p> <ul style="list-style-type: none"> <li>- name of the new Shunting area manager</li> <li>- contact possibilities to the new Shunting area manager</li> <li>- if any, ID of <a href="#">handheld terminal</a>.</li> </ul>

## Shunting

3433			<b>End temporary shunting area with handheld terminal</b>
3434	Precondition		All movements inside the temporary shunting area have ended or the Signaller needs the temporary shunting area ended. The Shunting area manager has a handheld terminal available.
3435	Purpose		Ensure that all trains have exited SH-mode and all moveable elements are detected, and then hand back control of the infrastructure to the Signaller.
			<b>PROCEDURE</b>
3436	Shunting area manager		<p>The agreed timing of an established <a href="#">temporary shunting area</a> is displayed on the <a href="#">handheld terminal</a>.</p> <p>If a temporary shunting area is not ended within the agreed timing a message will be indicated on the handheld terminal and the <a href="#">signalling control display</a>.</p>
3437	Shunting area manager		The Shunting area manager must request the <a href="#">temporary shunting area</a> to be ended at the agreed time, as far as possible.
3438	Signaller		If the <a href="#">temporary shunting area</a> is not ended at the agreed time, the Signaller must contact the Shunting area manager and request the temporary shunting area ended or agree to extend the duration of the temporary shunting area.
3439	Shunting area manager		Before the Shunting area manager can request a <a href="#">temporary shunting area</a> ended, the Shunting area manager must ensure that all trains inside the temporary shunting area have exited <a href="#">SH-mode</a> and all moveable elements are set in the correct position.
3440	Shunting area manager		The Shunting area manager must request to end the <a href="#">temporary shunting area</a> by selecting the appropriate temporary shunting area on the <a href="#">handheld terminal</a> .
3441	Signaller, Shunting area manager		<p>When the <a href="#">signalling system</a> receives a request to end a <a href="#">temporary shunting area</a> by a <a href="#">handheld terminal</a>, the signalling system can only end the temporary shunting area, if no <a href="#">routes</a> are set into the area. The handheld terminal displays a confirmation when the temporary shunting area is ended.</p> <p>When a temporary shunting area is ended this will be displayed on the <a href="#">signalling control display</a>.</p>
3877	Signaller		When a request to end a <a href="#">temporary shunting area</a> appears on the <a href="#">signalling control display</a> , the signaller must assess whether the area can be ended as requested. The signaller must either approve or reject the request.
3794	Signaller		The Signaller must ensure an entry in the Signaller log when the <a href="#">temporary shunting area</a> is ended.
3442	Shunting area manager		The Shunting area manager must observe confirmation that the <a href="#">signalling system</a> has ended the <a href="#">temporary shunting area</a> on the <a href="#">handheld terminal</a> before leaving the area.

## Shunting

3445			<b>End temporary shunting area without handheld terminal</b>
3446	Precondition		All movements inside the temporary shunting area are concluded or the Signaller needs the temporary shunting area ended. No handheld terminal is available.
3447	Purpose		Ensure that all trains have exited SH-mode and all moveable elements are in a lockable position, and then hand back control of the infrastructure to the Signaller.
			<b><u>PROCEDURE</u></b>
3449	Shunting area manager		The Shunting area manager must request the <a href="#">temporary shunting area</a> ended at the agreed time as far as possible.
3450	Signaller		If the <a href="#">temporary shunting area</a> has not been ended at the agreed time, the Signaller must contact the Shunting area manager and request the temporary shunting area ended or agree to extend the duration of the temporary shunting area.
3451	Shunting area manager		Before the Shunting area manager can request to end a <a href="#">temporary shunting area</a> , the Shunting area manager must ensure that all trains inside the temporary shunting area have exited <a href="#">SH-mode</a> and all moveable elements are in the correct lie.
3452	Shunting area manager		The Shunting area manager must request to end a <a href="#">temporary shunting area</a> by contacting the Signaller and report <a href="#">Shunting area manager ID</a> and temporary shunting area.
3453	Signaller		When the Signaller receives a request to end a <a href="#">temporary shunting area</a> from a Shunting area manager, the Signaller must: <ol style="list-style-type: none"> <li>1. Verify that the Shunting area manager is registered as responsible for the temporary shunting area</li> <li>2. Enter the request into the <a href="#">signalling system</a>.</li> </ol>
3454	Signaller		When the <a href="#">signalling system</a> receives a request to end a <a href="#">temporary shunting area</a> by a <a href="#">handheld terminal</a> , the signalling system can only end the temporary shunting area, if no <a href="#">routes</a> are set into the area.  When a temporary shunting area is ended this will be displayed on the <a href="#">signalling control display</a> .
3455	Signaller		The Signaller must verify from indications on the <a href="#">signalling control display</a> that the <a href="#">signalling system</a> has ended the <a href="#">temporary shunting area</a> .  The Signaller must inform the Shunting area manager when the temporary shunting area is ended.
3878	Signaller		The Signaller must ensure an entry in the Signaller log when the <a href="#">temporary shunting area</a> is ended.
3456	Shunting area manager		The Shunting area manager must await Signaller confirmation that the <a href="#">temporary shunting area</a> is ended before leaving the area.

# Communication

---

CO.2		<b>Introduction</b>
CO.3	All	It is of vital importance for the safety of the railway that communication between the roles defined by ORF ensures that the right people communicate and that the right understanding of messages are achieved. To avoid any confusion only necessary communication is allowed. Brevity is important, and message exchanges should be kept as clear and concise as possible.
CO.4	All	Think before you initiate a message exchange; know what you want to say and if it is a lengthy message, write it down if necessary before initiating the message.
CO.5		<b>Language</b>
CO.6	All	All communication mandated by ORF must be conducted in Danish. Messages must be short and unambiguous. The terminology of ORF must be used and where standard phrases are prescribed their use is mandatory.
CO.7	All	Names, numbers and identifiers are never to be abbreviated.
CO.8		<b>Message classes</b>
CO.9		<b>Safety messages</b>
CO.10	All	All messages containing content of relevance to railway safety are called safety messages. Safety messages are given in writing or verbally but do always follow the defined message structure.  The standard phraseology must be used for exchange of safety messages.
CO.11	All	You must only act upon the content of any safety messages other than emergency messages once the correct reception of the message has been confirmed by the sender of the message.
CO.12	All	In the event that more than one safety message is to be exchanged the safety messages must be completed and verified one by one.

CO.13		<b>Emergency messages</b>
CO.14	All	Emergency messages are safety messages.
CO.15	All	<p>Emergency messages are intended to give urgent <a href="#">operational instructions</a> that are directly linked to the safety of the railway. Emergency messages will lose their purpose of preventing or limiting an <a href="#">incident</a> if delayed. Emergency messages are similar to safety messages but follow a shortened message structure to allow speedy transmission and application.</p> <p>Emergency messages must contain information about where the incident has occurred, and the type as well as extent of incident, to enable the receiver to initiate the required actions to minimise the effects of the incident.</p>
CO.16	All	<p>Due to their urgent and imperative nature emergency messages:</p> <ul style="list-style-type: none"> <li>- may be sent or received while performing other operations,</li> <li>- may skip the identification part of the message structure</li> <li>- must be repeated at least once by the sender</li> <li>- must be supplemented by further information as soon as possible.</li> </ul>
CO.17		<b>Operational Instructions</b>
CO.18	All	<a href="#">Operational Instructions</a> are safety messages. Forms for some safety messages exists in the <a href="#">Book of Forms</a> . These safety messages must be transmitted using the relevant form.
CO.19	All	When initiating an exchange of a safety message for which an <a href="#">Operational Instruction</a> form exists, you must instruct the receiver about which Operational Instruction form to use.
CO.20	All	<p>When you receive a safety message for which an <a href="#">Operational Instruction</a> form exists you must bring out the form as instructed and fill in the form using the information given by the sender of the message.</p> <p>You must inform the sender when the form is ready to be filled in.</p>
CO.21	All	When a form is used to transmit a safety messages, the form must be completed by the sender prior to transmitting the message so that the full text of the message can be sent in one single transmission.
CO.22	All	All <a href="#">Operational Instructions</a> carry a unique authorisation. The safety message is only valid when this number is included in the Operational Instruction. The authorisation is decided by the sender.
CO.23	Driver	The Driver must only complete an <a href="#">Operational Instructions</a> when the <a href="#">train</a> is at a standstill.
CO.24	Driver	The Driver must request that information is repeated or elaborated if it is unclear or ambiguous.
CO.25	All	To avoid confusion, the information required to be completed on the <a href="#">Operational Instruction</a> form should be communicated in the order in which it appears on the form.

CO.26		<b>Informative messages</b>
CO.27	All	Informative messages are not safety messages. Exchange of informative messages does not require the use of standard phrases.
CO.28	All	Informative messages contain information of operational importance but have no relevance to railway safety. Informative messages do not have to follow the message structure but must still be clear and concise as to their content and meaning.
CO.29		<b>Message structure</b>
CO.30	All	The transmission of safety messages falls into 3 stages: <ul style="list-style-type: none"> <li>- identification and request</li> <li>- transmission of message</li> <li>- termination of communication exchange.</li> </ul>
CO.31		<b>Identification and request</b>
CO.32	All	When communicating you must make sure you are communicating to the right person. Before transmitting any safety message other than an emergency message the persons who are going to communicate must identify themselves. The identity of receiver and sender of safety messages must be clearly stated.
CO.33	All	The valid possible identifications of receiver and sender of safety messages are: <ul style="list-style-type: none"> <li>- name of TCC</li> <li>- <u>train running number</u></li> <li>- name of Railway Undertaking</li> <li>- user role and name.</li> </ul>
CO.34	All	The identification to be used if several valid identities exist, is the one that most clearly identifies the function, identity and context of the sender and receiver.
CO.35	All	When you communicate any safety message other than emergency messages you must ensure that the identity of the person you are communicating with is clearly and unambiguously identified.
CO.36	All	When you initiate a communication exchange you must always state the reason for the exchange before commencing transmission of the message. The reason must clearly identify if the communication is a safety message exchange.



CO.37		<b>Transmission of message</b>
CO.38	All	All safety messages must be transmitted using the standard terminology. The standard phrases may not always be adequate. In that case, use whatever words are necessary so your message can be understood.
CO.39	All	When you receive a safety message other than an emergency message you must read-back the message by: <ul style="list-style-type: none"> <li>- repeating all numbers and other identifiers in the message</li> <li>- repeating the key points of the message</li> <li>- identifying the receiver of the message.</li> </ul>
CO.40	All	As the sender of a safety message you must verify that the message has been received correctly by verifying a read-back of the message. You must always give an acknowledgement of conformity or non-conformity of the read-back.
CO.41	All	If necessary the receiver and the sender must exchange questions and clarifications until both parties agree on the content of the safety message.
CO.42	All	Safety messages transmitted by other means than <a href="#">train radio</a> or phone always requires a return receipt to confirm the message has been read by the receiver. The return receipt must be issued by a person or validating system to guarantee the message has been read and not just delivered. An automatic return receipt of an e-mail cannot suffice as return receipt of a safety message.
CO.43		<b>Termination</b>
CO.44	All	When the communication exchange has been successfully completed or the exchange has to be put on hold this must be clearly communicated to both parties.
CO.45		<b>Use of radio and phone</b>
CO.46	All	When you receive a call from one of the users defined in ORF you must as far as it is safe and practicable to do so answer the call immediately. When you receive a call you must always evaluate if the call can be answered without diverting your attention from other safety critical tasks.
CO.47		<b>Train radio</b>
CO.48	Driver Signaller	Safety messages between Signaller and Driver must take advantage of the <a href="#">train radio</a> whenever available. Safety messages exchanged via radio must be exchanged verbally and never using any text capability of the radio.
CO.49	Driver	Whenever a Driver becomes aware that a <a href="#">train radio</a> has failed, or if the <a href="#">train</a> is not fitted with a train radio, the Driver must inform the Signaller and provide the number of a mobile phone that the Driver can be reached on if available.

CO.50		<b>Emergency calls and other group calls</b>
CO.51	Driver Signaller	During emergency calls and other group calls Drivers not initiating the call are only to contribute to the communication if explicitly invited to do so by the Signaller or if the Driver possess information vital to reduce or avoid imminent danger.
CO.52	Signaller	Emergency calls and other group calls initiated by the Signaller must be repeated.
CO.53		<b>Mobile phone</b>
CO.54	All	Safety messages exchanged via mobile phone must be exchanged verbally and never using any text capability of the phone. The mobile phone is only to be used when no <a href="#">train radio</a> is available.  The mobile phone number of a Driver can be requested from the Railway Undertaking.
CO.55	All	If the Signaller is called using a mobile phone you must always inform the Signaller of your mobile phone number and current location during the initial communication unless you know that the Signaller already has this information.
CO.56	Signaller	The Signaller must record the mobile phone number in the <a href="#">Signaller log</a> against a <a href="#">train running number</a> , <a href="#">possession</a> , <a href="#">shunting area</a> etc. as appropriate.
CO.57	Signaller	The Signaller is only to call using a mobile phone if a landline phone is not available.
CO.58		<b>Logging of communication</b>
CO.59	All	All communication must be expected to be logged and all voice communication recorded. The logs and recordings can be used for <a href="#">incident investigation</a> and in anonymized form for education purposes without further notification.
CO.60	Signaller	The Signaller must record all relevant safety messages in the <a href="#">Signaller log</a> unless the information is automatically recorded in the Signaller log, or another automated system.
CO.61	Signaller	When communicating with a person not performing the role of a user within ORF and the communication takes place on a device that is recorded the Signaller must inform the person of the conversation being recorded.
CO.62		<b>Transfer</b>
CO.63	Signaller	A Signaller receiving a safety message related to an area outside their area of control must relay the safety message to the Signaller controlling the area.
CO.64	Signaller	When a Signaller transfer the caller to the correct Signaller, the Signaller must inform the caller where the call is being transferred to so as not to introduce any further confusion.
CO.65		<b>Terminology</b>

CO.66

**Standard phrases**

CO.67 All

Where a standard phrase is available you must use this for exchange of safety messages to promote understating of your message and to counter ambiguity.

CO.170

Phrase	Meaning	Use
«Mayday, mayday, mayday»	A hazardous situation has occurred, and any necessary precautions must be taken to avoid or minimise the consequences of the situation.	Used to start an emergency message, where no function for emergency calls (e.g. GSM-R) exists.
«This is a safety message»	This message provides information of relevance to railway safety.	Used to initiate a safety message exchange.
«Over»	Transmission ended, expects other party to speak.	Used to transfer the opportunity to speak to the opposite party.
«Received»	Message has been received.	Used to confirm that the sent message has been received.
«Say again»	Ask the other party to repeat the current message from the top.	Used by the receiver of a message to have the message repeated in the event of poor reception or misunderstanding.
«Wait»	A temporary break in communication that does not break the connection.	Used to keep the other party waiting if break is temporary and does not break the connection.
«Correct»	Message has been read-back correctly.	Used by sender to confirm correct read-back of the message.
«Error» + I say again	The message is wrong.	Used by the sender when an error in the read-back is discovered.
«Out»	Message has ended.	Used to signify that communication exchange has ended.
«I call again»	Connection is going to be broken but will be resumed.	Used to break incomplete message exchange to be completed later.
«Train (number) is authorised to pass the unprotected level crossing (number)»	Level crossing cannot be protected, and you must consider the level crossing as unprotected when proceeding.	Verbal authority used to allow a train to pass an unprotected level crossing.
«Error during transmission of message»	There is an error in the transmitted message.	Used when an error is identified during the transmission of the message. The message is restarted from the top.
«Say again (+ speak slowly)»	The sender must repeat the message in a slow and comprehensible way.	Used when the message cannot be fully understood.
«Cancel Operational Instruction (number)»	Cancel the transmission of an Operational Instruction.	Used by the sender to cancel the transmission of an Operational Instruction.
«Error (+ prepare new Operational Instruction (number)»	An error in the transmission has been identified and a new Operational Instruction must be prepared.	Used when the sender identifies an error during transmission of an Operational Instruction.
«Prepare Operational Instruction (number)»	Find the form and get ready to note down the instructions.	Used when the Driver must find an Operational Instruction and prepare to fill it out.
«Ready for Operational Instruction (number)»	Ready to receive an Operational Instruction.	Used when the Driver is ready to fill out an Operational Instruction.

CO.165 Shunter Driver

Standard phrases which are only used during a shunting movement.

CO.172

Phrase	Meaning	Use
«Forward»	The traction unit must pull. If no wagons are coupled, or wagons are coupled in both ends, «Forward» means the direction faced by the Driver	Used to instruct a Driver to pull during a shunting movement.
«Backward»	The traction unit must push. If no wagons are coupled, or wagons are coupled in both ends, «Backward» means the opposite direction of the direction faced by the Driver.	Used to instruct a Driver to push during a shunting movement.
«Slowly»	The traction unit must reduce speed.	Used to instruct at Driver during to reduce speed during a shunting movement.  Can be supplemented with the message «x metres to stop»
«Stop»	The traction unit must come to a standstill.	Bruges til at instruere lokomotivføreren om at stoppe rangerbevægelsen.

CO.68

## Phonetic alphabet

CO.69 All

You must use the phonetic alphabet for single letters and to spell out groups of letters or difficult words. The phonetic alphabet is available in this Communications section.

Additionally you must use the phonetic alphabet when communication conditions are such that the information cannot be easily received without their use, for example in a high noise environment.

CO.70

## Numbers

CO.71 All

You must transmit numbers one digit at a time.  
Example: **Train** 2183 = "Train two-one-eight-three".

CO.72 All

Time must be given in Danish local time, in plain language using 24 h notation.

Example: 10:52 = "Ten fifty-two".  
Example: 23:59 = "Twenty-three fifty-nine".  
Example: 00:00 = "Zero-zero zero-zero".

CO.73 All

Dates must be expressed in the Danish notation, in plain language using day and month).

Example: 19.12 = 19. December = "Nineteenth of December".

CO.74 All

Distances must be expressed in kilometres and speeds in kilometres per hour.

Example: km 23,1 = "Kilometre two-three-point-one".  
Example: 20 km/h = "Two-zero kilometres-per-hour".

CO.75

## Use of hand signals

CO.167

### Night signals

CO.168 All

Night signals must be used from sunset to sunrise and during low visibility weather conditions.



CO.141

### Danger

CO.142 All

The hand signal for danger is the hand signal used to try and stop a **train** or a vehicle approaching a hazardous area, or an area expected to be hazardous.

CO.174

Phrase	Day	Night	Instruction to driver
«Danger» Hand signal «Danger» (day and night)	 		The Driver must try to stop the train or vehicle before entering the hazardous area. <b>Note:</b> In case a red light is not available - use whatever light colour is available.

CO.145

### Shunting







CO.76 Driver  
Shunter

Hand signals may be used during shunting movements when the Driver and Shunter have identified themselves to each other and a continuous visual contact can be maintained between the Driver and Shunter for the duration of the shunting movement.

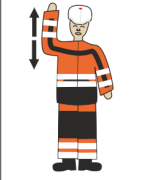
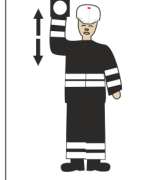
CO.77 Driver  
Shunter

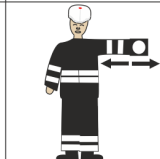
Hand signals can substitute the four standard shunting phrases of:

CO.176

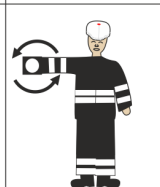
Phrase	Day	Night	Instruktion to Driver
«Forward» Hand signal «Forward» (day and night)			The traction unit must pull. If no wagons are coupled, or wagons are coupled in both ends, «Forward» means the direction faced by the Driver.
«Backward» Hand signal «Backward» (day and night)			The traction unit must push. If no wagons are coupled, or wagons are coupled in both ends, «Backward» means the opposite direction of the direction faced by the Driver.
«Slowly» Hand signal «Slowly» (day and night)			The traction unit must reduce speed.
«Stop» Hand signal «Stop» (day and night)			The traction unit must come to a standstill.



CO.160

### Road traffic, stop

CO.161 All

The hand signal "Road traffic, stop" can be used when a level crossing cannot or must not be activated. The hand signal is shown towards the road traffic just in front of the level crossing.

CO.178

Phrase	Day	Night	Instruktion to Driver
«Road traffic, stop» Hand signal «Road traffic stop» (day and night)			Road traffic must stop.

CO.81

### Phonetic Alphabet

CO.180

Character	Telephony	Character	Telephony	Character	Telephony
"A"	Alfa	"K"	Kilo	"U"	Unifo
"B"	Bravo	"L"	Lima	"V"	Victo
"C"	Charlie	"M"	Mike	"W"	Whish
"D"	Delta	"N"	November	"X"	X-ra
"E"	Echo	"O"	Oscar	"Y"	Yank
"F"	Foxtrot	"P"	Papa	"Z"	Zulu
"G"	Golf	"Q"	Quebec	"Æ"	Æg
"H"	Hotel	"R"	Romeo	"Ø"	Ødi
"I"	India	"S"	Sierra	"Å"	Åse
"J"	Juliet	"T"	Tango		

CO.83

## Numbers

CO.182

Character	Telephony	Character	Telephony	Character	Telephony
«1»	One	«5»	Five	«9»	Nine
«2»	Two	«6»	Six	«0»	Zero
«3»	Three	«7»	Seven	«,» (decimal point)	Point
«4»	Four	«8»	Eight	«.» (full stop)	Stop

CO.184

## Examples of communication

CO.185

### Example of Emergency Message

CO.186 All

The Signaller has used the *signalling system* functionality to Emergency stop all supervised *trains* in an area because of an emergency. The Signaller contacts the Driver of an unsupervised train running on an *Operational Instruction* number 1 and order the train to stop.

CO.187 Signaller

"Mayday mayday, mayday. *Train running number* 5-4-8-4-4 emergency stop. There is a reported obstruction on the tracks at Randers. Mayday mayday, mayday. Train running number 5-4-8-4-4 emergency stop. There is a reported obstruction on the tracks at Randers. Over."

CO.188 Driver

"Received. *Train running number* 5-4-8-4-4 is stopping. Over."

CO.202

"Correct. Out."

CO.189

**Example of Operational Instruction Message**

CO.190

All

*The Driver of a train, which is at a standstill at the end of a movement authority, in front of ETCS stop marker Kj-0-1-2, contacts the signaller and request an authority to proceed.*

*The Signaller has exhausted all possibilities for issuing a movement authority. The Train must proceed on an Operational Instruction number 1.*

CO.191

Driver

“This is a safety message. Train running number 4-6-3-4 I am at standstill in front of ETCS stop marker Kilo-Juliet-0-1-2 and request an authority to proceed. Over.”

CO.192

Signaller

“Received. Train running number 4-6-3-4 is at a standstill in front of ETCS stop marker Kilo-Juliet-0-1-2 and request an authority to proceed. Over.”

CO.193

Driver

“Correct. Out.”

CO.194

All

*The Signaller fills out an Operational Instruction number 1 and contacts the driver.*

CO.195

Signaller

“This is a safety message. Prepare Operational Instruction number 1. Over.”

CO.196

Driver

“Received. Ready for Operational Instruction number 1. Over.”

CO.197

Signaller

“Train running number 4-6-3-4, it is the 17th of February 2025, this is traffic control centre East, mark with a cross in box 1-stop-1-0 and write Kilo-Juliet-0-1-2 and delete kilometer, mark with a cross in box X-ray-stop-4-1 and write 3-0 km/h from kilometer 1-2-3-point-1 to kilometer 1-2-3-point-3 and delete marker board. Over.”

CO.198

Driver

“Received. Train running number 4-6-3-4, it is the 17th of February 2025, I'm talking to traffic control centre East, I have marked with a cross in box 1-stop-1-0 and written Kilo-Juliet-0-1-2 and deleted kilometer, I have marked with a cross in box X-ray-stop-4-1 and written 3-0 km/h from kilometer 1-2-3-point-1 to kilometer 1-2-3-point-3 and deleted marker board. Over.”

CO.199

Signaller

“Correct. Your unique identification is 1-4-5-3. Over.”

CO.200

Driver

“Received. My unique identification is 1-4-5-3. Over.”

CO.201

Signaller

“Correct. Out.”

# Rules for Working and walking about in the Infrastructure

---

TW4		<b>General regulations</b>
TW5		<b>Application of the rules</b>
TW6		<b>Areas without public access</b>
TW7	PICOSS	The Rules for working in infrastructure applies whenever work takes place in an area, managed by Banedanmark, where regular public access is not allowed, and the work takes place within 4 metres of the nearest rail of an <a href="#">operational railway</a> as well as, whenever work takes place in a technical installation that could affect railway safety regardless of the work being carried out on behalf of Banedanmark, another company or a private person.
TW8		<b>Areas with public access</b>
TW9	PICOSS TWSC	When work takes place in an area, managed by Banedanmark, with regular public access or in an area managed by a private company or person and borders on the area managed by Banedanmark the Track Work Safety Coordinator (TWSC) will decide the necessary railway safety measures in cooperation with the contractor and the client.
TW12		<b>Competencies for walking about and work in the track</b>
TW13		<b>Walking about in the tracks</b>
TW14	PICOSS TWSC	<p>Walking about in the tracks defines the situation when a person is moving within the prescribed <a href="#">personal safety distance</a> of an <a href="#">operational railway</a>.</p> <p>When walking about in the tracks, full attention must be directed towards <a href="#">train</a> movements and no tools or items must be carried, if they prevent the person from moving freely.</p> <p>Simple tasks can be carried out while Walking about in the tracks but only following a specific assessment and subsequent approval by the TWSC on the condition that a written instruction has been given.</p>



TW15		<b>Working in or near an operational railway</b>
TW16	PICOSS TWSC	<p>Working in or near an <u>operational railway</u> is to be understood as the situation where one or more of the following conditions are present:</p> <ul style="list-style-type: none"> <li>- the <u>personal safety distance</u> is violated and full attention is not directed towards <u>train</u> movements</li> <li>- the safety distances towards the live parts of the catenary system are violated</li> <li>- the safety distances for machinery, equipment or tools are violated</li> <li>- the functionality or stability of the infrastructure including any technical equipment are affected</li> <li>- the TWSC has assessed that the specific work can only take place safely if performed within a <u>possession</u>.</li> </ul>
TW17		<b>ID card</b>
TW18	PICOSS	<p>Persons are only allowed within 4 metres of the nearest rail in an area without public access, when:</p> <ul style="list-style-type: none"> <li>- it is necessary to perform a specific task</li> <li>- when necessary instructions on personal safety have been received</li> <li>- when meeting the required competence of the specific task</li> <li>- in <u>possession</u> of a valid ID card.</li> </ul> <p>When walking in a group each individual has full responsibility for their own safety.</p>
TW19		<b>Persons without an ID card</b>
TW20		<b>Urgent arising tasks</b>
TW21	PICOSS O&M coordinator	<p>Persons without valid ID cards who are called upon to assist in acute <u>corrective maintenance</u> tasks or in emergencies must receive special safety instructions relating to the specific task and the specific geographical location from the PICOSS.</p> <p>The person calling on assistance is responsible for briefing all personnel with the safety instructions before work is commenced.</p> <p>If assistance is called in connection with infrastructure work overseen by a PICOSS, it is always the responsibility of the PICOSS to carry out the safety instructions.</p> <p>Persons without valid ID cards must be accompanied by a railway safety trained member of staff</p> <p>The person accompanying must be in the immediate vicinity of the person being accompanied.</p>
TW24		<b>Authorities</b>
TW25	Infrastructure Manager	<p>Authorities have access to the <u>operational railway</u> without the need to possess an ID card e.g. police are permitted to walk about the tracks where their duties require this.</p>

TW116		<b>Work planning</b>
TW117		<b>Planning responsibility</b>
TW118		<b>Infrastructure manager conditions</b>
TW119	Infrastructure Manager	<p>When larger railway infrastructure works requiring changes to <a href="#">train</a> operation are planned Banedanmark must ensure an assessment is carried out by the person responsible for Traffic Operation. The assessment is to consider:</p> <ul style="list-style-type: none"> <li>- The ability to operate safely and in accordance with current regulations and procedures, and</li> <li>- the need for extra staff.</li> </ul> <p>Banedanmark must appoint a TWSC as an advisor to ensure that railway safety rules and regulation are given due consideration.</p>
TW120		<b>Contractor conditions</b>
TW121	Contractor	<p>The contractor is responsible for ensuring that:</p> <ul style="list-style-type: none"> <li>- all risks are identified and mitigated through planning and instruction</li> <li>- an approved <a href="#">railway safety plan</a> is available before commencing work</li> <li>- all work is planned and can be executed in accordance with railway safety rules and regulations</li> <li>- all necessary agreements are in place with the person responsible for Traffic Operation</li> <li>- all participating crew with any kind of safety responsibility have the necessary training and experience in accordance with the scope and complexity of the work</li> <li>- the PICOSS has the necessary knowledge of the geography and any special conditions of the worksite</li> <li>- the PICOSS has all necessary information on the execution of the work</li> <li>- the PICOSS is given the necessary time to compare the physical conditions at the worksite with the information in the railway safety plan before allowing the work to commence.</li> </ul>
TW122		<b>Work leading to changes in safety or train operation</b>
TW123		<b>Mutual arrangements</b>
TW124	Contractor Infrastructure Manager	<p>If an infrastructure work leads to one or more of the following conditions:</p> <ul style="list-style-type: none"> <li>- a need for a <a href="#">possession</a></li> <li>- <a href="#">train</a> movements requiring a schedule</li> <li>- <a href="#">temporary speed restrictions</a>, other changes to driving conditions or technical systems</li> <li>- working in the technical equipment connected to a <a href="#">level crossing</a> (fjernbane only)</li> <li>- a need for a <a href="#">catenary isolation</a></li> <li>- other traffic or railway safety related deviations,</li> </ul> <p>the contractor must enter into necessary agreements with the person responsible for Traffic Operation.</p>

TW125

### Announcements

TW126

Infrastructure Manager

The person responsible for Traffic Operation must ensure that all planned infrastructure work leading to one or more of the following conditions:

- [possession](#)
- changes in driving conditions
- [catenary isolation](#)
- other conditions influencing the use of the infrastructure

are announced for all staff affected by the changes.

TW127

### Railway safety plan

TW128

#### General conditions

TW129

PICOSS  
Contractor  
TWSC

For all planned infrastructure work an approved [railway safety plan](#) describing railway safety for the work in question must be available to the PICOSS, before the work commences.

Railway safety plans are only valid once they have been approved by a TWSC.

Procedures describing the production and approval process of railway safety plans are administered by the TWSC.

Before commencing planned work on or at an [operational railway](#), an approved railway safety plan must be produced.

The railway safety plan describes a number of safety arrangements regarding the work in question.

TW130

#### Several work teams working in the same possession

TW131

PICOSS  
Contractor  
TWSC

The TWSC must assess and stipulate the coordination of railway safety between all planned infrastructure works and ensure that it is described in the [railway safety plan](#).

The assessment is done based on reports given by the contractors.

The TWSC can stipulate that instead of one railway safety plan covering a concoction of works in a [possession](#) separate railway safety plans must be produced for each separate part and supplemented by a coordinating railway safety plan.

The TWSC must ensure that the coordinating railway safety plan is drawn up. In addition the TWSC can stipulate that a PICOSS must be connected to each separate work inside one specific possession identifying one PICOP with sole responsibility of the entire possession.

TW132		<b>Corrective maintenance</b>
TW133		<b>General conditions</b>
TW134	O&M coordinator Infrastructure Manager	<u>Corrective maintenance</u> is correction of acute faults and error in the infrastructure.
		Corrective maintenance is transformed into planned maintenance when the effect on Traffic Operation has been assessed and analyzed by a Banedanmark planner and the necessary plans and changes have been entered into the <u>signalling system</u> and <u>railway safety plan</u> has been approved by the TWSC.
TW135		<b>Railway safety plan</b>
TW136	PICOSS	As a substitute for an approved <u>railway safety plan</u> the PICOSS must complete an on-site assessment and planning of railway safety.
		The planning and assessment must be described in the PICOSS log book and recorded as a substitute for the railway safety plan.
TW137		<b>Agreements made with the person responsible for Traffic Operation</b>
TW138	PICOSS Signaller	The PICOSS communicates the necessary arrangements connected to <u>corrective maintenance</u> directly with the Signaller.
TW139		<b>Corrective maintenance in relation to an established possession</b>
TW140	PICOSS PICOP	If a need for <u>corrective maintenance</u> occurs in relation to an established <u>possession</u> the PICOSS must contact the PICOP for the possession concerned.
		The PICOP for the possession must ensure that all:
		<ul style="list-style-type: none"> <li>- works inside the possession are coordinated</li> <li>- responsibilities are clearly defined</li> <li>- crew participating in the work receives the necessary instructions.</li> </ul>
TW265		<b>Execution of infrastructure work</b>
TW266		<b>General conditions</b>
TW267		Infrastructure work can be done as
		<ul style="list-style-type: none"> <li>- work in <u>possession</u></li> <li>- work with watchman</li> <li>- special work.</li> </ul>

TW268	<b>Precautions before initiating infrastructure work</b>
TW269	<p>Before initiating infrastructure work, the PICOP must ensure that</p> <ul style="list-style-type: none"> <li>- is in <u>possession</u> of all documents relating to the work in question</li> <li>- the work can be carried out as envisaged in the planning</li> <li>- everyone participating in the work has the necessary skills</li> <li>- everyone participating in the work is instructed in matters that have railway safety implications for their work</li> <li>- all agreements regarding the execution of the work have been entered into with any Work supervisor and Shunters</li> <li>- all railway safety measures for the execution of the work have been established</li> <li>- all matters that have railway safety or traffic consequences have been finally agreed with the Signaller.</li> </ul>
TW270	<p>Before work commences, the Work supervisor must ensure that</p> <ul style="list-style-type: none"> <li>- all agreements regarding the execution of the work have been entered into with the PICOSS</li> <li>- all technical requirements for the work in question have been met</li> <li>- that the PICOSS has been informed of all matters that have or may have railway safety or traffic significance.</li> </ul>
TW26	<b>Possession</b>
TW27	<b>General conditions</b>
TW28	<p><b>PICOP</b>      <u>Possession</u> work can take place in all types of tracks and be used to carry out all types of infrastructure work.</p>
TW29	<b>Planned possessions</b>
TW30	<b>General conditions</b>
TW31	<p><b>PICOP</b>      Work inside a <u>planned possession</u> cannot commence until final <u>possession</u> details have been agreed between the PICOP and the Signaller and the <u>worksite protection</u> has been put in place.</p>
TW271	<b>Especially regarding the establishment and ending of a possession without a handheld terminal</b>
TW272	<b>Application</b>
TW273	<p>It must be agreed between the Person responsible for traffic operation and the Contractor where, when, under what conditions and to what extent a <u>possession</u> may be established or ended without the use of a <u>handheld terminal</u>.</p>
TW274	<b>Announcement</b>
TW275	<p>The Person responsible for traffic operation must ensure that the agreements are made known to the Signaller and the PICOP to the relevant extent.</p>

TW35		<b>Worksite protection</b>
TW36	PICOP	<p>Before commencing any work inside a <a href="#">possession</a>, <a href="#">worksite protection</a> must be established.</p> <p>At every entrance to a worksite, from where a <a href="#">train</a> or <a href="#">vehicle</a> can approach, a dual faced stop marker must be placed between the rails of the track.</p> <p>The dual faced stop marker indicates the boundary of the worksite to Trackworkers working in the possession and warns Drivers approaching or leaving the worksite. It is the responsibility of the PICOP that the dual faced stop markers are always correctly in place to protect the worksite.</p> <p>The dual faced stop markers must always be placed within the boundary of the possession. If infrastructure work is to be carried out between two parallel tracks, both tracks must be under possession. If infrastructure work is required in the overlap between two adjacent sections, the possession must include both sections.</p> <p>The dual faced stop markers can be removed briefly to allow driving in and out of the worksite, but must be replaced in the correct position immediately after the passage.</p>
TW37	PICOP	<p>Prior to starting the work, the PICOP must ensure that the highest level of protection of the work is achieved by contacting the Signaller and ensuring that all related <a href="#">possessions</a> are established and any corresponding <a href="#">temporary speed restrictions</a> are activated.</p>
TW38		<b>Driving inside a possession</b>
TW39	PICOP	<p>All driving inside a <a href="#">possession</a> is performed as a <a href="#">shunting movement</a> with a maximum speed of 25 km/h and the PICOP controlling the movement as <a href="#">Shunting area</a> manager. The limits of shunting within the possession are marked by the dual faced stop markers.</p> <p>The Signaller may only allow driving into the possession after obtaining authorisation from the PICOP.</p> <p>Trains are only allowed to exit the possession with authorisation from the Signaller.</p>
TW276		<b>Work movement</b>
TW277		<p>Low-speed operation of rail mounted machinery that perform work while running is referred to as a work movement and, upon instruction from the PICOP, may be carried out without a Shunter.</p> <p>The overall framework for the use of work movements must be set out in the <a href="#">railway safety plan</a>.</p>
TW40		<b>Delays in planned work</b>
TW41	PICOP	<p>The PICOP must immediately inform the Signaller if an agreed start or finish time for a <a href="#">possession</a> cannot be respected.</p>

TW42		<b>Ending the work</b>
TW44	PICOP Work supervisor	Before concluding the work, the Work supervisor must complete any necessary technical procedures then report to the PICOP when the infrastructure is ready to be handed back to operational use. The Work supervisor must inform the PICOP if any technical restrictions are imposed to any parts of the infrastructure e.g. <a href="#">temporary speed restrictions</a> , <a href="#">clamped points</a> etc.
TW46	PICOP	Before ending the <a href="#">possession</a> the PICOP must await a report from the Work supervisor that the infrastructure including all technical installations are ready for operational use. If any restrictions apply to any part of the infrastructure, and these restrictions are not automatically generated in the <a href="#">signalling system</a> , it is the responsibility of the PICOP to report this to the Signaller before ending the possession.
TW48		<b>Watchman</b>
TW49		<b>Application</b>
TW50	PICOSS	A watchman is required where work is to be carried out in an <a href="#">operational railway</a> within the <a href="#">personal safety distance</a> and the track is not protected by a <a href="#">possession</a> .
TW51		<b>Precondition</b>
TW52	PICOSS TWSC	A single watchman is positioned to watch all directions and warn the work crew of approaching <a href="#">trains</a> .  Protecting a work crew by the use of a single watchman is allowed when:  <ul style="list-style-type: none"> <li>- the time needed to vacate the track does not exceed 5 seconds</li> <li>- vacating the track can happen to a place outside the <a href="#">personal safety distance</a></li> <li>- only light hand tools are used</li> <li>- the sighting distance for trains provides sufficient time to vacate the track</li> <li>- a maximum of 4 persons are participating in the work</li> <li>- an acoustic warning device is used or if a maximum of 2 persons are participating in the work direct communication is used.</li> </ul> <p>The TWSC can demand that additional watchmen must be used to achieve sufficiently safe working conditions.</p> <p>Pending a specific assessment of the location and the conditions of the work to take place the TWSC can allow more than 4 persons to participate in the work.</p>

TW53		<b>Vacating the track</b>
TW54	<b>PICOSS</b> <b>TWSC</b>	<p>When vacating the track the work crew must move to a location respecting the <u>personal safety distance</u> of the operational track or to a track where a <u>possession</u> is established.</p> <p>Vacating the track by crossing other operational tracks is not allowed without specific agreement from the TWSC.</p> <p>The TWSC can based on a specific assessment of the operational conditions and the geographical location, allow that the track can be cleared by crossing an operational track.</p>
TW55		<b>Time needed to vacate</b>
TW56	<b>PICOSS</b> <b>TWSC</b>	<p>The time needed to vacate the track must not exceed 5 seconds unless the TWSC has assessed that a time exceeding 5 seconds is permissible.</p> <p>The time needed to vacate the track is determined as the time from the watchman giving the warning to the last person and all tools being removed to a <u>position of safety</u>.</p> <p>The time needed to vacate the track must be assessed by a test, carried out at the worksite before commencing the work.</p>



TW57

**Sighting distance**TW58 **PICOSS**  
**Watchman**

The sighting distance is the minimum distance required between the approaching train and the worksite when the Watchman warns the work crew.

If the sighting distance is not able to be obtained either a temporary speed restriction or a possession is requested to be able to do the work.

In the sighting distance a safety margin (slipping time) of 10 seconds is included.

Sighting distances are determined from the following table:

TW254

Hastighed i km/t	Udsigtslængde fra arbejdssted i meter med fem sekunders rømningstid	Hastighed i km/t	Udsigtslængde fra arbejdssted i meter med fem sekunders rømningstid
250	1050	80	340
240	1000	75	320
220	920	70	300
200	840	60	250
180	750	50	210
160	670	40	170
140	590	30	130
120	500	25	110
100	420	20	90
90	380	10	50

TW255

Hastighed i km/t	Udsigtslængde fra arbejdssted i meter med fem sekunders rømningstid	Hastighed i km/t	Udsigtslængde fra arbejdssted i meter med fem sekunders rømningstid
250	1050	80	340
240	1000	75	320
220	920	70	300
200	840	60	250
180	750	50	210
160	670	40	170
140	590	30	130
120	500	25	110
100	420	20	90
90	380	10	50

TW59		<b>Warning of a work crew</b>
TW60	Watchman	<p>The acoustic device used to warn the work crew must be approved by Banedanmark.</p> <p>If the work crew consists of a maximum of 2 persons the use of an acoustic warning device can be substituted by verbal or physical communication.</p> <p>The Watchman must immediately warn the work crew when an approaching <a href="#">train</a> is observed.</p> <p>The warning must be continued until all members of the work crew have begun vacating the track.</p> <p>When work is performed at night time and warning is given by the use of an acoustic device the warning must continue until the train has passed the worksite unless the Watchman has received an indication (e.g. a radio call) that the entire work crew has begun vacating the track.</p> <p>If the sighting distance is unexpectedly reduced (e.g. because of fog or snow) the Watchman must immediately warn the work crew that the track must be cleared. The Watchman must inform the PICOSS about the interruption.</p>
TW61		<b>Special warning devices (fjernbane only)</b>
TW62	PICOSS	<p>If work is performed in the vicinity of a <a href="#">level crossing</a> the acoustic warning device of the level crossing may be used as a substitute for a watchman.</p> <p>The conditions for using the acoustic warning device of a level crossing as a substitute must be stipulated in the <a href="#">railway safety plan</a>.</p>
TW64		<b>Watchman regulations</b>
TW65	PICOSS Watchman	<p>A Watchman may only perform his duties for a maximum of one hour without a break. The break between lookout duties for a Watchman must be at least 15 minutes.</p> <p>Two persons can perform duty as Watchman and part of work crew in turns.</p> <p>A watchman must not:</p> <ul style="list-style-type: none"> <li>- perform other duties while being on lookout duty</li> <li>- participate in conversation</li> <li>- use a mobile phone or other distracting device (e.g. music or game device).</li> </ul> <p>The Watchman must always carry a blue armband or a safety vest with the inscription "VAGT" when on lookout duty. The person carrying the armband or the safety vest with the inscription "VAGT" is the person responsible for warning the work crew of approaching <a href="#">trains</a>.</p>

TW68		<b>PICOSS regulations</b>
TW69	<b>PICOSS</b>	<p>Before commencing work the PICOSS must ensure that:</p> <ul style="list-style-type: none"> <li>- speed and sighting distances are recorded in the log book. This may be omitted if it has been assessed that the specific conditions are already covered by the <a href="#">railway safety plan</a></li> <li>- the warning devices can be heard by the work crew</li> <li>- the Watchman has received the necessary instructions in the use of all warning devices in use</li> <li>- the Watchman is placed at a location ensuring the necessary sighting distance and that the Watchman has received the necessary instructions about warning the work crew</li> <li>- the work crew has received the necessary instructions about the meaning of any warning signal used by the Watchman and to which side they must vacate the track.</li> </ul>
TW70		<b>Special weather conditions</b>
TW71	<b>PICOSS</b>	<p>If a sufficient sighting distance cannot be guaranteed due to reduced visibility, the work must be called off or planned to be carried out inside a <a href="#">possession</a>.</p> <p>This also applies in case of changing weather conditions (e.g. snow, fog or heavy rain).</p>
TW72	<b>PICOSS</b>	<p>If the sound of the warning devices cannot be clearly heard due to noise or special weather conditions the work must be called off or planned to be carried out inside a <a href="#">possession</a>.</p>
TW75		<b>Special work</b>
TW76		<b>Application of the rules</b>
TW77	<b>PICOSS</b>	<p>Special work conditions apply when one the following conditions are all fulfilled:</p> <ul style="list-style-type: none"> <li>- the safety distance to an operational track is not violated</li> <li>- the worksite is situated in an area with regular public access</li> <li>- there is a risk that the safety- and/or protective distances is violated</li> <li>- the work is performed in track under renewal.</li> </ul>
TW78		<b>Safety instructions and procedures</b>
TW79	<b>PICOSS TWSC</b>	<p>The application of safety instructions and procedures are determined by the TWSC on a case by case basis. The TWSC will cooperate with the person in charge of Traffic Operations as necessary.</p> <p>The conditions on which the work can be carried out will be stipulated in a <a href="#">railway safety plan</a> or through a special instruction note.</p>

TW279

## End of the work

TW280

## General conditions

TW281

The Work supervisor must, upon completion of the work and after the technical procedures have been complied with, report the technical facility(ies) in question that has been worked on as ready for operational use.

The report must be given to the PICOSS and must contain all information about any restrictions on the use of the technical facilities, including whether there are speed restrictions or locking of points.

TW282

Before reporting the work completed, the PICOSS must obtain notification from the Work supervisor that the technical facilities are ready for operation and whether there are any restrictions on the use of the infrastructure that has been worked on.

The PICOSS informs the Signaller of the extent to which the infrastructure that has been worked on is functioning and that the work has been completed.

TW33

## Log and troubleshooting book

TW34

PICOP

A PICOP log is personally issued and is used by the PICOP and PICOSS to record necessary safety related information relating to their duties. The PICOP and PICOSS must always be prepared to show their PICOP log to the TWSC or Banedanmark incident investigator on request.

The PICOP will primarily record [possession](#) details relating to establishing, handing over and ending of a possession.

The PICOSS will primarily record details which substitute a [railway safety plan](#), including clearing time, sighting and safety distances in relation to planning of possessions for [corrective maintenance](#).

TW82

## Fence and shielding

TW83

### Fence

TW84

PICOSS  
TWSC

The construction of the fence must be of a firm and stable character with red and white vertical stripes. Tape barriers are not allowed.

Fencing may be omitted after assessment from the TWSC, or in the following situations:

- the physical boundary between the [personal safety distance](#) and the worksite is marked by a firm and stable shielding
- the physical boundary between the personal safety distance and the worksite consists of a ditch or a picket fence
- a person is placed to ensure that the personal safety distance is not violated.

TW85		<b>Shielding</b>
TW86	PICOSS	<p>Working inside the <u>personal safety distance</u> to an <u>operational railway</u> is allowed if a shielding is set up as a physical boundary.</p> <p>The shielding must be of a sufficient robustness and height to prevent materials and tools as well as persons from passing through the shielding.</p> <p>The shielding must be set up no closer than 1,60 m to the nearest rail. If regular <u>shunting movements</u> take place in the track, the shielding must be set up at least 1,80 m from the nearest rail.</p> <p>Shieldings and other temporary fences made of conductive materials put up closer than 5 m from the nearest live overhead equipment, must be earthed.</p> <p>Individual parts of a shielding or fence must be assembled into one unit according to the relevant catenary power regulations.</p>
TW87		<b>Setting up fences or shieldings</b>
TW88	PICOSS	<p>Any protective fence or shielding must be set up prior to commencing work and it must remain in place until all work has concluded.</p> <p>When setting up a fence or shielding all safety distances towards the <u>operational railway</u> must be observed unless necessary safety measures has been taken.</p> <p>If there is a need to remove the fence or shielding temporarily for working purposes, necessary safety measures must be taken to substitute the fence or the shielding before removing it. The fence or shielding must be re-established before removing any substitute safety measures.</p>
TW89		<b>Safety distances</b>
TW90		<b>Safety distance for people</b>
TW91	PICOSS	<p>The <u>personal safety distance</u> to operational tracks measured from the nearest rail are:</p> <ul style="list-style-type: none"> <li>- 1.75 m for speeds of 120 km/h or below</li> <li>- 2.25 m for speeds above 120 km/h.</li> </ul>
TW92	PICOSS	<p>Persons walking on or near the line must stay outside the safety distances when <u>trains</u> are passing.</p>
TW228	PICOSS	<p>In areas where footpaths are established, they can be used to remain, or to vacate to, when <u>trains</u> are approaching.</p>
TW93		<b>Marking of safety distance for people</b>
TW94	PICOSS	<p>If work is to take place closer than 1 m to the <u>personal safety distance</u> of an <u>operational railway</u> a fence must be set up marking the physical boundary.</p>

TW95		<b>Safety distances for machinery, equipment and tools</b>
TW96		<b>General conditions</b>
TW97	PICOSS	The safety distance towards an <a href="#">operational railway</a> must only be violated if there is a <a href="#">possession</a> in the track concerned. If a Signaller protected area is applied in the area concerned, a short-term violation may be permitted, e.g. for turning around with a lift or crane.
TW98	PICOSS	All equipment and tools must be placed outside the safety distance ensuring that it cannot on purpose or by accident fall or slide into a position where it can cause damage to the infrastructure, <a href="#">trains</a> , fences or shieldings.
TW99		<b>Safety distance for working machinery</b>
TW100		<b>Non-rail mounted working machinery</b>
TW101	PICOSS	The safety distance for non-rail mounted working machinery, to the nearest rail of an <a href="#">operational railway</a> , is 2 m.  Non-rail mounted working machinery must, with respect to the pivot limiter, be controlled in such a way that the machine itself cannot turn unintentionally and hence, violate the safety distance.  If, in exceptional cases, the working direction of the machine cannot be controlled, it must be ensured that the machine is at standstill well in advance of any traffic passing on the operational railway.
TW232		<b>Rail mounted working machinery</b>
TW233	PICOSS	The safety distance for rail mounted working machinery, to the nearest rail of an adjacent tracks of an <a href="#">operational railway</a> , is 1,6 metres.
TW234		<b>Pivot limiter</b>
TW235	PICOSS	By use of an active pivot limiter, or other technical device, it must be ensured that no part of working machinery can unintentionally, or through operation error, violate the safety distance during the work.
TW102		<b>General safety regulations</b>
TW103		<b>Marker boards</b>
TW104	PICOSS	When executing any kind of work on or near operational tracks, the visibility of marker boards must not be obstructed.
TW105		<b>Setting up a temporary track crossing</b>
TW106	PICOSS Infrastructure Manager	If a temporary <a href="#">track crossing</a> is needed prior approval is required from both the person responsible for Technical Operation and the person responsible for Traffic Operation. The person responsible for Traffic Operation must assess the necessary safety measures to be taken when using the track crossing and ensure that necessary instructions are available.

TW107		<b>Crossing a track with vehicles and materials</b>
TW108		<b>General conditions</b>
TW109	PICOSS	<p>Crossing an operational track when transporting heavy materials, heavy machinery and/or slow driving <a href="#">vehicles</a> requires an approval from the Signaller in every single case unless other instructions have been given by the person responsible for Traffic Operation. All crossing of tracks to and from the worksite are only to take place in the track crossings designed for this purpose.</p> <p>To avoid damage to the rails or any technical equipment it is not allowed to drag tools or materials across the rail.</p>
TW112		<b>Working near a level crossing (fjernbane only)</b>
TW113	PICOSS	<p>When working near a <a href="#">level crossing</a> it is the responsibility of the PICOSS to ensure that the level crossing is manually controlled if necessary as stipulated in the specific <a href="#">railway safety plan</a>. The PICOSS may need to request the Signaller to prevent the issuing of movement authorities over the level crossing.</p>
TW252		<b>Corrective maintenance or normal maintenance in a level crossing (Fjernbane only)</b>
TW253	PICOSS	<p>If the <a href="#">level crossing</a> needs to be manually controlled for test purposes during <a href="#">corrective maintenance</a> or normal maintenance, the PICOSS must request the Signaller to prevent the issuing of movement authorities over the level crossing during the test.</p>
TW114		<b>Technical installations</b>
TW115	PICOSS	<p>Before commencing any work it is the responsibility of the contractor to plan all necessary precautions to protect technical installations from being damaged.</p> <p>If technical installations are damaged the O&amp;M coordinator must be informed immediately.</p>
TW141		<b>Catenary system</b>

TW142

## The structure of the catenary system

TW143

### General regulations

TW144

All

The catenary system on the Fjernbane supplies 25,000 or 2 x 25,000 volts alternating current and on the S-bane supplies 1650 volts direct current.

The masts of the catenary system are different to other high voltage masts, and are not always equipped with high voltage warning signs.

The overhead wire is normally suspended at a height of 5,5 metres above the top of the rails, but can e.g. under a bridge, be as low as 4,92 metres.

It is prohibited and highly dangerous to get closer than 1,75 metres to the closest live pantograph or live overhead equipment.

Live overhead equipment is illustrated with red on the illustration shown below.

Be aware that all parts of the overhead equipment carries the same voltage and therefore protective distances applies to all parts of the overhead equipment.

TW256

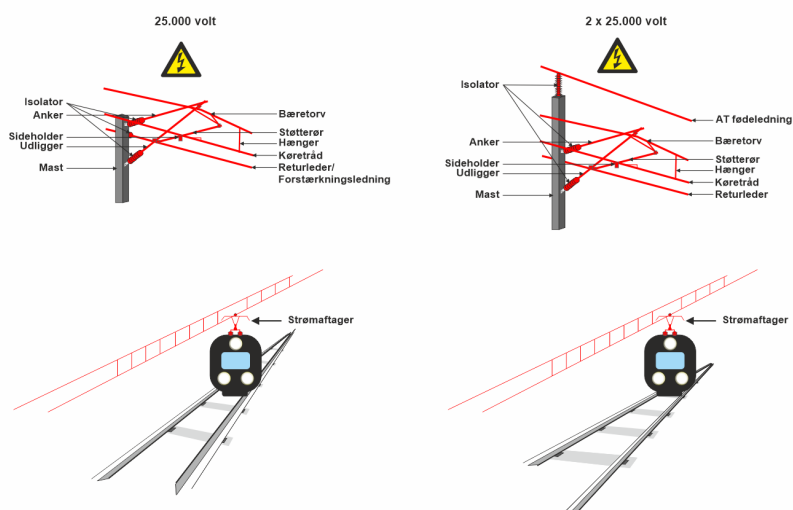

TW145

### Return current and protective earthing arrangements

TW146

All

To ensure that the return current can return into the catenary system in a safe way, two different types of cables are used which are connected to the rails. These are return current cables which leads return current back into the system as well as protective **earthing** cables connected to conductive objects close to overhead equipment.

For higher visibility the cables are placed on top of the ballast or the sleepers. On platforms and other areas with public access the cables are placed in protective piping.

On S-bane the protective earthing arrangements are placed above mast valves or spark gap.

If any damage to the return current cables or protective earthing arrangements is observed, the Catenary manager or catenary staff present at the location must be informed immediately.



TW236

**Earth conductor (fjernbane only)**

TW237

**All**

To lead the return current back into the catenary system, earth conductors are placed on some of the catenary masts. In the 25,000 volt system for every approximately 3000 metres and in the 2 x 25,000 volt system for very approximately 600 metres.

Masts with earth conductors are equipped with high voltage warning signs.

The earth conductor is a connection with four heavy black cables (marked in red on the illustration below) between the catenary mast and return rail.

Disconnecting the earth conductor is extremely dangerous and potentially lethal. If all four cables of the earth conductor are disconnected simultaneously, they must not be touched and catenary staff must be called upon immediately.

TW257

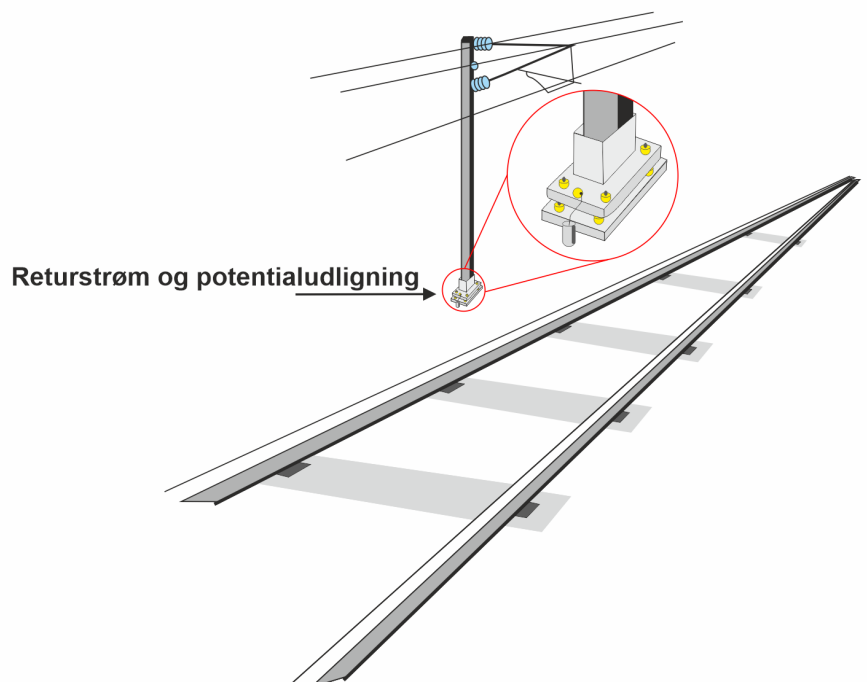
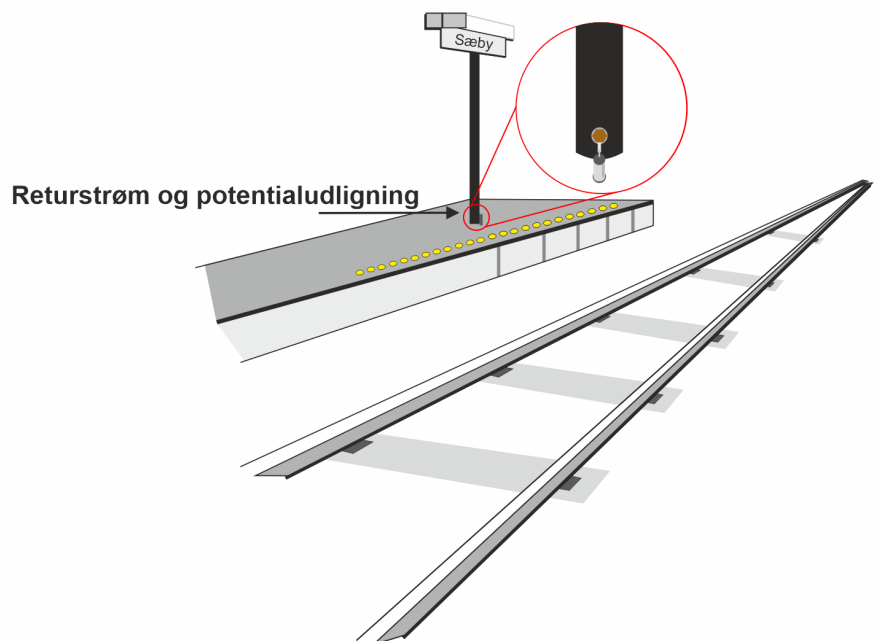

TW239

**Working in or near the catenary system**

TW240

**General conditions**

TW241

All

Failure to comply with protective distances to live parts of the catenary system is prohibited and potentially lethal.

If the protective distances to the catenary system cannot be respected, no work may be performed before the power has been isolated and a work permit has been handed over by the Catenary field leader.

The work permit is a verification that the necessary parts of the catenary system have been isolated and [earthing](#) arrangements are put in place.

If track work requires the return rail to be cut, preventive measures need to be taken to secure the return current flow of the catenary system.

TW242

**Working during catenary isolation**

TW243

All

Work is only allowed to be carried out between the signs marking the "work limit". These signs are placed by the Catenary field leader.

Only when the catenary is isolated and maintenance work with the catenary system is performed are any person or machinery allowed to come closer to any part of the catenary system than 30 cm.

TW258

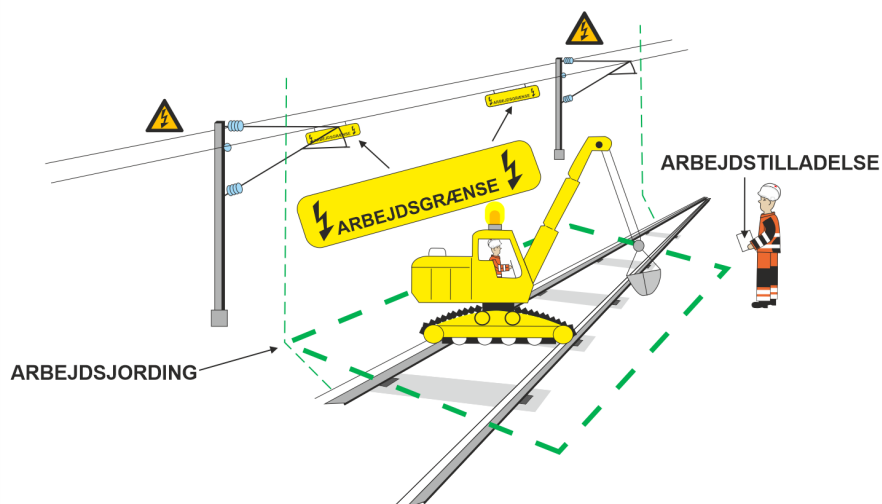

TW147

**Protective distances**

TW148

**General conditions**

TW149

All

Protective distances apply to the entire catenary system including pantographs on electric [traction units](#).

When assessing the protective distance it is dangerous and forbidden to measure directly to live overhead equipment with any kind of tool (e.g. a folding ruler).

TW151

**Persons and tools**

TW152 **All**

The protective distance to live overhead equipment is 1,75 m for persons and light tools. When using longer tools, e.g. a level, the length of the tool must be added to the protective distance of 1,75 m.

TW259

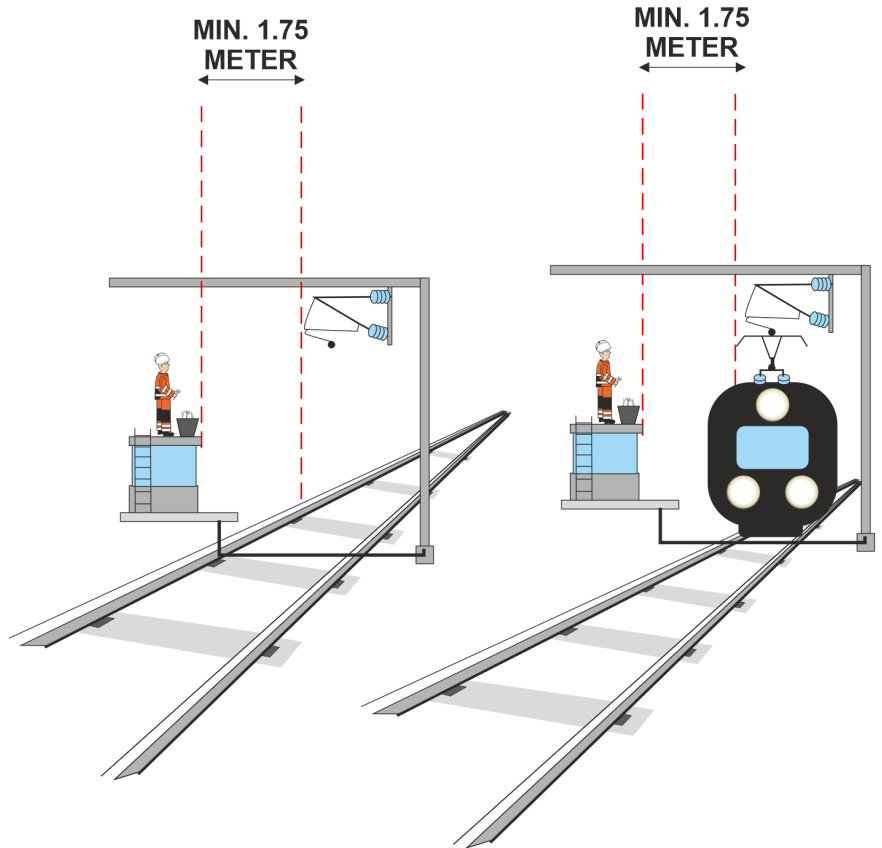

TW246 **All**

It is prohibited and dangerous to climb or stay on the roof, platform or any kind of construction on **rolling stock** when this can lead to unintentionally entering the protective distance of 1,75 m to live overhead equipment.

TW260

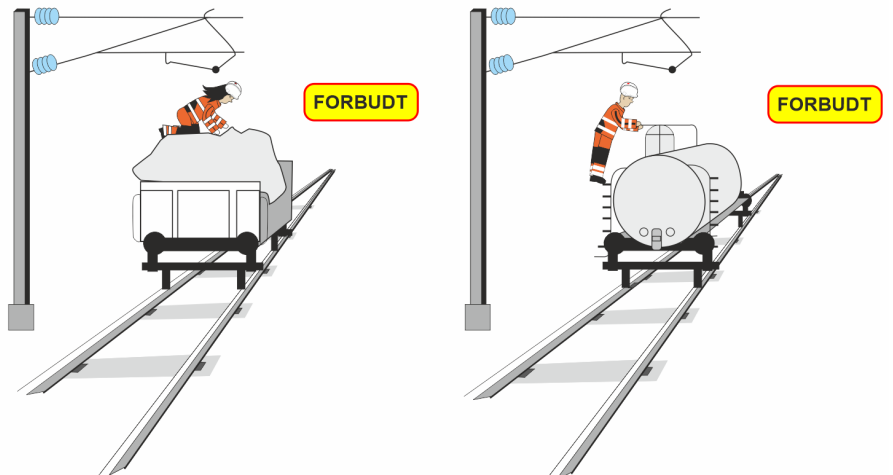

TW153

### Ladders and other long objects

TW154

All

When working with ladders and other long objects special attention must be taken to avoid entering the protective distance of 1,75 m even by accident.

Only ladders made of a non conductive material must be employed when working near live overhead equipment.

TW261

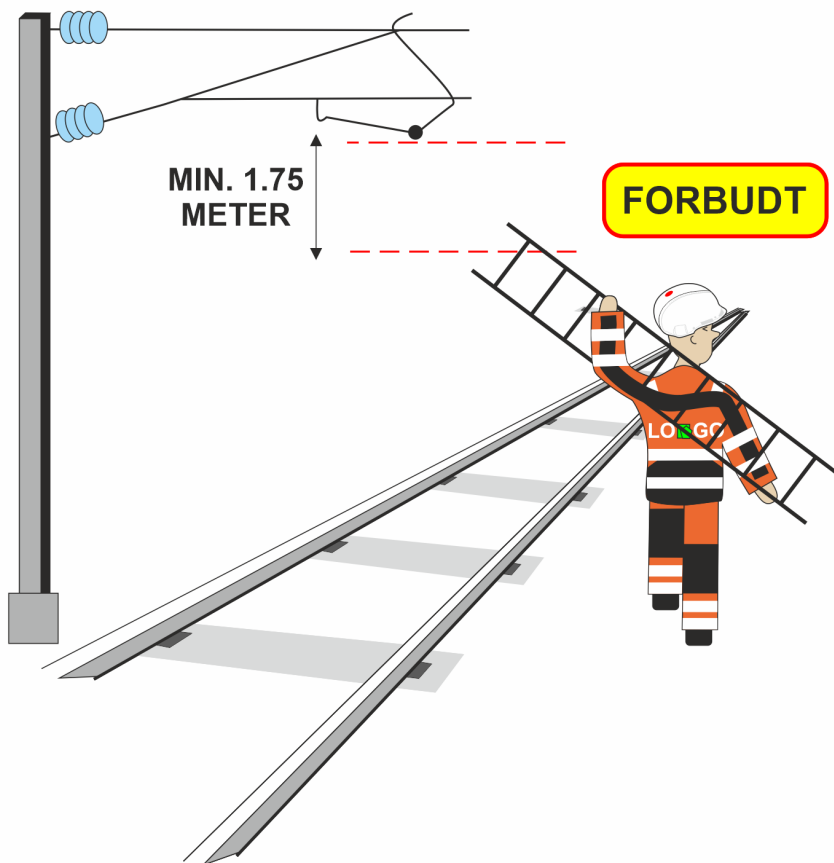

TW155

### Use of water hose and pressure washer

TW156

All

It is dangerous and prohibited to enter a protective distance of 10 m to live catenary equipment when working with water hoses and/or pressure washers unless a specific work procedure has been approved by Catenary Management.

If there is a need to work with water hoses and/or pressure washers closer than 10 m to catenary equipment, the catenary equipment must be isolated.

TW262

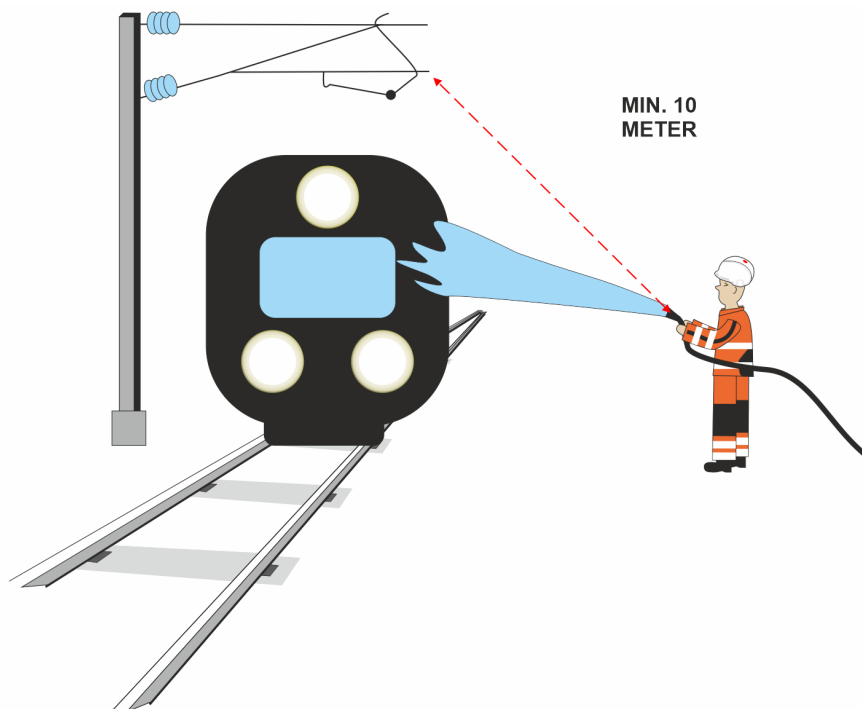

TW157

### Larger machinery

TW158

PICOSS  
Catenary manager

The protective distance to live overhead equipment is 5 m for larger machinery (e.g. mechanical diggers or excavators). Larger machinery must be equipped with necessary safety devices ensuring that no part of the machinery can enter the protective distance to live overhead equipment even by accident or human error.

When assessing the protective distances to live overhead equipment the following assumptions apply:

- calm wind
- the measurement is done horizontally from a line vertical to the nearest part of the overhead equipment
- allowance for unpredictable movements of machinery and of a swinging load up to 20 degrees (corresponding to 38 cm per meter)
- allowance for electric traction units passing the worksite.

Catenary Management can grant deviations from the general regulations and set specific conditions for working larger machinery, including requirements on earthing of machinery according to the relevant catenary system regulations.

TW263

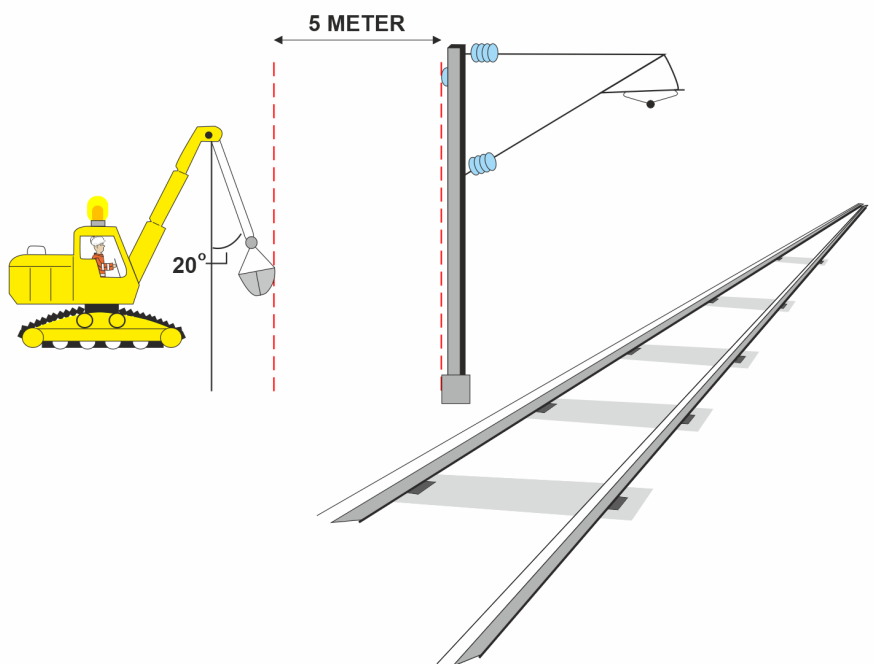
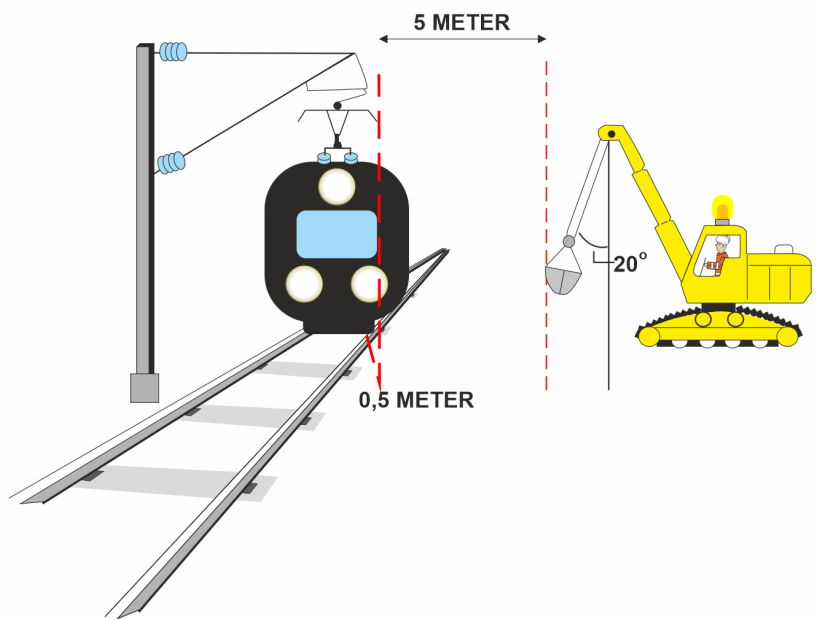
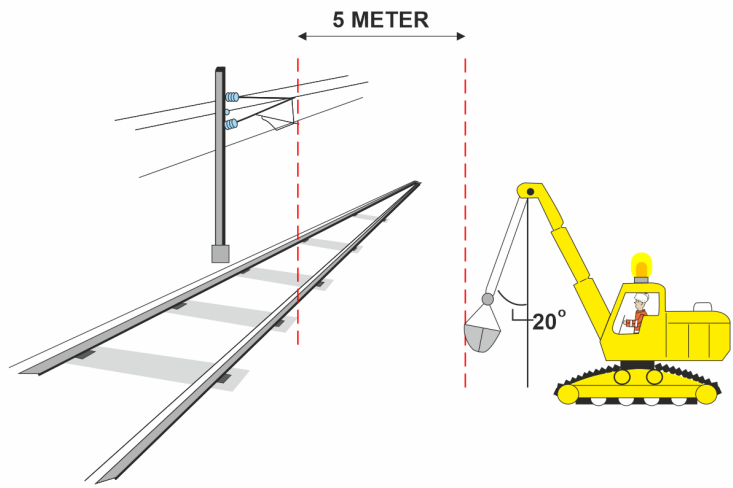

TW159

**Smaller machinery**

TW160

**PICOSS**

Smaller machinery may perform work under live overhead equipment provided they are prevented from reaching higher than 3 m from the top of the rail e.g. by special safety devices or with any other special restrictions.

Earthing of machinery of a smaller scale is not required.

TW264

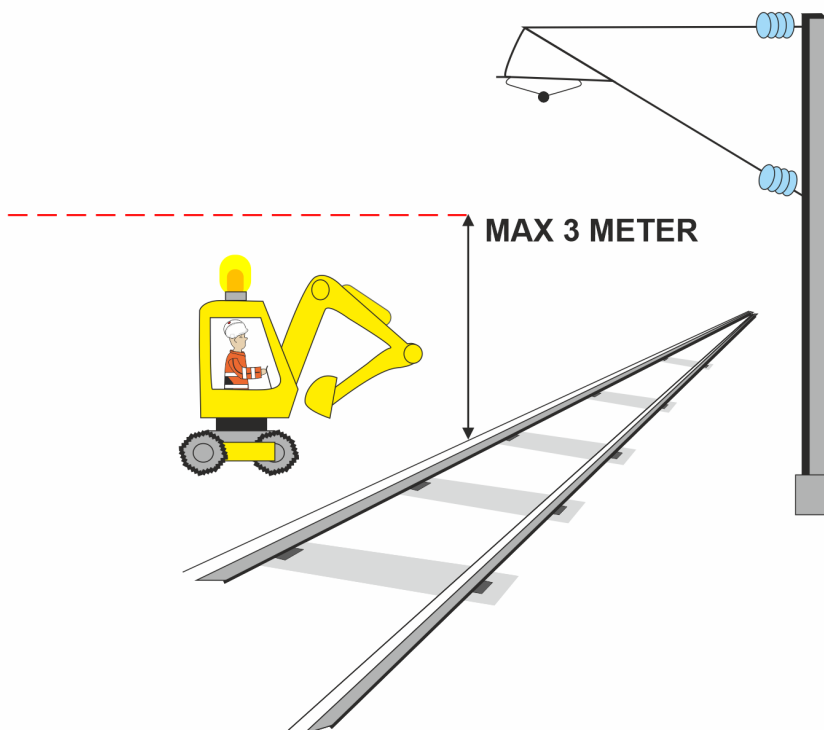

TW161

**Planned catenary isolation**

TW162

**Announcements**

TW163

**Catenary manager**  
**Contractor**  
**Signaller**

Requests for a catenary isolation are made to the catenary planning office.

Announcement of planned catenary isolations are published by the catenary planning office and contain:

- unique identification number
- name, telephone number, company and job position of the person who requested the catenary isolation
- period(s) (time, date) for the planned work
- specification of the geographical location of the worksite (line, track, km)
- the nature of the work and whether use of tools and machinery of a larger scale is planned
- i hvilke(t) koblingsområde(r) kørestrømmen udkobles
- specification of catenary sections where the power will be isolated.

A catenary isolation can only apply to one worksite in one period of time and for one catenary power cut off interval at a time, within the announced period of time.

The Signaller in charge of the areas involved must acknowledge the receipt of an announcement of a planned catenary isolation to the catenary planning office.

TW164		<b>Catenary isolation protection</b>
TW165		<b>Starting a catenary isolation</b>
TW166	Catenary field leader	In case of bad weather, particularly thunder and lightning, the Catenary field leader must assess if <a href="#">earthing</a> can be carried out safely and if work can begin.
TW167	Catenary manager Catenary field leader	The Catenary field leader requests a catenary power shut-off from the Catenary manager.
TW168	Catenary manager Catenary field leader	When the procedure for establishing a <a href="#">planned catenary isolation</a> is completed, the Catenary manager shuts off the catenary power in relevant sections and reports to the Catenary field leader that the <a href="#">earthing</a> procedure can begin.
TW169	PICOSS Catenary field leader	The Catenary field leader carries out the <a href="#">earthing</a> on both sides of the worksite, sets up "work limit" signs and gives a written work permit to the PICOSS identifying when the work can begin.  The written work permit must contain an unambiguous indication of the area where the work can take place as well as a confirmation, that the catenary system in that specific area is earthed.
TW229		<b>Electrical rolling stock in earthed area</b>
TW230	Catenary field leader Catenary manager	If the Catenary field leader is informed by the Catenary manager that electrical <a href="#">rolling stock</a> has entered into an earthed area, the Catenary field leader must check all <a href="#">earthing</a> arrangements in the isolated area. When all earthing arrangements are checked and found fit for purpose, the Catenary field leader must report to the PICOSS and the Catenary manager that it is safe to continue the work.
TW170		<b>Ending catenary isolation</b>
TW171	Catenary field leader	In case of bad weather, particularly thunder and lightning, the Catenary field leader must assess if the work must be stopped temporarily or if the work must be ended and if <a href="#">earthing</a> equipment can be removed safely.
TW172	PICOSS Catenary field leader	When the time is up for ending a <a href="#">catenary isolation</a> , the PICOSS signs and returns the written work permit to the Catenary field leader confirming that all persons and equipment are outside the protective distance.
TW173	Catenary manager Catenary field leader	The Catenary field leader reports to the Catenary manager when the <a href="#">earthing</a> equipment has been removed and catenary power can be reconnected.
TW203		<b>Handing over new or changed infrastructure</b>
TW204		<b>General conditions</b>
TW205	Contractor Infrastructure Manager	When handing over new or changed infrastructure the Person responsible for Technical Operation of the particular technical subset of the infrastructure, such as track, <a href="#">level crossing</a> (fjernbane only) and catenary system, must be informed of the condition of the infrastructure.



TW206		<b>Handing over new or changed infrastructure (large scale)</b>
TW207	<b>PICOSS</b> <b>Infrastructure Manager</b> <b>O&amp;M coordinator</b>	<p>When handing over new or changed infrastructure on a larger scale the person responsible for Technical Operation must appoint a designated person as responsible for ensuring the handover. The designated person must ensure the safe handover of every specific technical subset of the infrastructure to the person responsible for Technical Operation.</p> <p>The designated person informs the O&amp;M coordinator when the infrastructure is handed over to operational use and of any technical restrictions and limitations on the use of the infrastructure.</p>
TW208		<b>Handing over new or changed infrastructure (smaller scale)</b>
TW209	<b>PICOSS</b> <b>Work supervisor</b> <b>Infrastructure Manager</b> <b>O&amp;M coordinator</b>	<p>When handing over new or changed infrastructure on a smaller scale where no designated person is responsible for ensuring the handover, the work supervisor or the PICOSS is responsible for ensuring the handover.</p> <p>The work supervisor or the PICOSS must ensure the safe handover of every specific technical subset of the infrastructure to the person responsible for Technical Operation.</p> <p>The work supervisor or the PICOSS informs the O&amp;M co-ordinator when the infrastructure is handed over to operational use and of any technical restrictions and limitations on the use of the infrastructure.</p>
TW210		<b>Conditions of the O&amp;M coordinator</b>
TW211	<b>O&amp;M coordinator</b>	<p>The O&amp;M coordinator must ensure that a record is made in the <a href="#">Signaller log</a> of:</p> <ul style="list-style-type: none"> <li>- the time of the handover</li> <li>- the name of who was responsible for the handover</li> <li>- any applicable restrictions in the use of the infrastructure.</li> </ul>
TW212		<b>Instruction on the use of new or changed infrastructure</b>
TW213	<b>Infrastructure Manager</b>	<p>Following any changes to existing infrastructure or adaptation of new infrastructure the person responsible for Technical Operation must ensure all users and maintainers are properly trained and instructed in the construction and operation of every subset of the infrastructure as necessary.</p>

# Appendix

FAP-10 **A - Book of forms**

FAP-65 **Operational Instruction 1-7**

FAP-86



## Operational Instruction 1-7

<input type="checkbox"/>	1. Permission to pass an EOA	[1.10*], [x.41], [x.95]
<input type="checkbox"/>	2. Permission to proceed after trip	[2.10*], [x.41], [x.90], [x.92], [x.95]
<input type="checkbox"/>	3. Obligation to remain at standstill	[3.10*], [x.95]
<input type="checkbox"/>	4. Revocation of an instruction	[4.10*], [x.95]
<input type="checkbox"/>	5. Obligation to run with speed restriction	[x.41*], [x.90], [x.92], [x.95]
<input type="checkbox"/>	6. Obligation to run on sight	[6.40*], [x.90*], [x.92*], [x.95]
<input type="checkbox"/>	7. Permission to start after preparing a movement	[7.10*], [7.20*], [x.41], [x.95]

A Train No*	B Date (dd/mm/yy)*	C Location of train	D Location of issuer*
<input type="checkbox"/>	[1.10] Is allowed to pass EOA at	<input type="text"/> <small>km/marker board</small>	
<input type="checkbox"/>	[2.10] If no MA is received, is allowed to proceed in SR		
<input type="checkbox"/>	[3.10] Remain at standstill in current location		
<input type="checkbox"/>	[4.10] Operational Instruction	<input type="text"/> is revoked <small>unique identification</small>	
<input type="checkbox"/>	[6.40] Run on sight	from <input type="text"/> to <input type="text"/> <small>km/marker board km/marker board</small>	
<input type="checkbox"/>	[7.10] Is allowed to start in SR		
<input type="checkbox"/>	[7.20] Is allowed to pass EOA at	<input type="text"/> <small>km/marker board</small>	
<input type="checkbox"/>	[x.41] Do not exceed the speed of	<input type="text"/> from <input type="text"/> to <input type="text"/> <small>km/h km/marker board km/marker board</small>	
<input type="checkbox"/>	[x.90] Examine the line for following reason	<input type="text"/> <small>free text</small>	
<input type="checkbox"/>	[x.92] and report findings to	<input type="text"/> <small>free text</small>	
<input type="checkbox"/>	[x.95] Additional instructions	<input type="text"/> <small>free text</small>	
<input type="text"/>			
<b>Z Unique Identification*</b>			

**User instruction**

Mark the relevant operational instruction (only one per form). Next to the individual operational instructions, it can be seen which sections can/should be used.

Mark with a cross the tick boxes that becomes valid, as follows:

In case of multiple options for the information, delete the non-valid options, as follows:

  
km/marker-board

Where \* is used the information is mandatory to complete. Mandatory sections can vary between each Operational instruction.

FAP-30

## Operational Instruction 21 - Backwards movement authorisation

FAP-92



# Operational Instruction 21

## Backwards movement authorisation

Train No.*	Date (dd/mm/yy)*	Location of train*	Location of issuer*
The train is authorized to move backward to: <input data-bbox="644 506 1003 560" type="text"/> * <small>km/marker board/platform</small>			
Additional instructions <input data-bbox="644 580 1377 752" type="text"/> <small>free text</small>			
Maximum permitted speed <input data-bbox="644 779 917 824" type="text"/> * <small>km/h</small>			
<input data-bbox="284 848 512 887" type="text"/> <b>Unique Identification*</b>			
<p><b>User instruction</b></p> <p>Where * is used the information is mandatory to complete.</p> <p>In case of multiple options for the information, delete the non-valid options, as follows: <input data-bbox="1003 994 1190 1032" type="text"/></p> <small>km/marker board/platform</small>			

FAP-26

## Operational Instruction 22 - Request working unit movement - Part A and B

FAP-88



# Operational Instruction 22

## Request working unit movement

### Part A - working unit data

(to be completed by the Driver before making the request)

Date*	Telephonenumber*	Company name*	
Working unit-ID*	Train length (meter)*	Train load (tonnes)*	Maximum speed (km/h)*
Train consist*			
<input type="checkbox"/> Unusual transport (UT)		UT circular numbers:	
<input type="checkbox"/> Hazardous goods		<i>If field is ticked, fill in information about <b>Hazardous goods</b> on the rear of the form</i>	
Start mission*	Preferred start time*	Destination*	Preferred arrival time*

### Part B - schedule for mission

(to be dictated by responsible Signaller)

<b>Train running Number: _____ is authorised to move with the following schedule:</b>			
Location	Arrival	Departure	Remarks

**User instruction**  
Where \* is used the information is mandatory to complete.



FAP-38

## B - Hazard warning plates

FAP-39

### CLASS 1 - Explosive substances and articles.

FAP-70



**Nr. 1**  
Underklasse 1.1, 1.2 og 1.3



**Nr. 1.4**  
Underklasse 1.4



**Nr. 1.5**  
Underklasse 1.5



**Nr. 1.6**  
Underklasse 1.6

- \* \* Angivelse af underklasse. Angives ikke, hvis de eksplosive egenskaber udgør en sekundær risiko.
- \* Angivelse af forenelighedsgruppe. Angives ikke, hvis de eksplosive egenskaber udgør en sekundær risiko.

FAP-41

## CLASS 2 - Gases

FAP-71



**Nr. 2.1**  
Brandfarlige gasser.

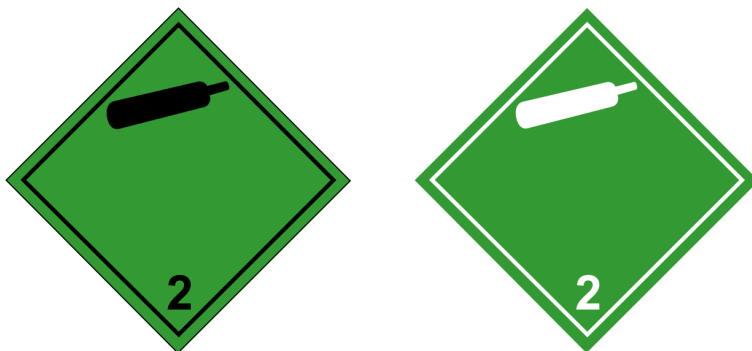

**Nr. 2.2**  
Ikke-brandfarlige, ikke-giftige gasser.



FAP-43

## CLASS 3 - Flammable liquids

FAP-72



FAP-45

**CLASS 4.1 - Flammable solid substances, self-reactive substances and solid desensitised explosives**

FAP-79



FAP-47

**CLASS 4.2 - Combustible substances**

FAP-80



FAP-49

**CLASS 4.3 - Substances which generate flammable gases when in contact with water**

FAP-73





FAP-51 **CLASS 5.1 - Oxidizing substances**

FAP-81



FAP-53 **CLASS 5.2 - Organic peroxide**

FAP-74



FAP-55 **CLASS 6.1 - Poisonous substances**

FAP-82



FAP-57 **CLASS 6.2 - Contagious substances**

FAP-83



FAP-59

### CLASS 7 - Radioactive substances

FAP-75



FAP-61

### CLASS 8 - Corrosive substances

FAP-84

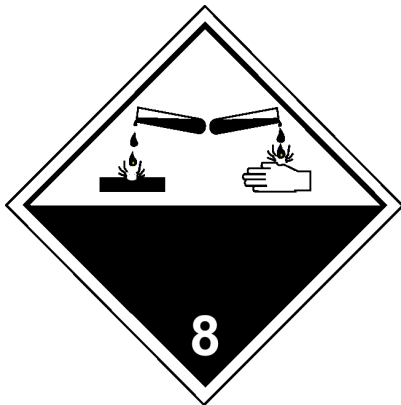

FAP-63

### CLASS 9 - Various hazardous substances and objects

FAP-76



FAP-77



FAP-78

